

DEVELOPMENT CONTROL DESIGN POLICY,
GUIDANCE AND STANDARDS 2015



Development Control Design Policy, Guidance and Standards 2015 (DC 15) has been developed by the **Malta Environment and Planning Authority (MEPA)** in collaboration with **Dr Antoine Zammit** BE&A (Hons)(Melit) MSc (Lond) PhD (Lond), *perit*, Founding Architect and Urban Designer at *studjurban* and Lecturer at the Department of Spatial Planning and Infrastructure, Faculty for the Built Environment, University of Malta.

Project Team

Malta Environment and Planning Authority | *studjurban*

DC 15 Work Group (WG)

Chairman: Perit Victor Sladden

Lead Author: Dr Antoine Zammit PhD, *perit*

Perit Annamaria Attard Montalto; Perit Raphael Axiaq; Mr. Joseph Magro Conti; Ing. Joseph Farrugia; Perit Joseph Bondin; Perit Christian Spiteri; and Perit Colin Zammit

© Cover image by Richard England, 2014

© Figures 10, 11, 12, 14, 15, 24, 25, 41, 42, 52, 53, 60, 73, 84, 94 and 95

by Rune Bo Jakobsen, 2015

All other figures by *studjurban* unless otherwise specified

Published by:

The Malta Environment & Planning Authority

P.O. Box 200

Marsa MRS 1000

Malta

Tel: (+356) 2290 0000

Fax: (+356) 2290 2295

Email: enquiries@mepa.org.mt

Website: www.mepa.org.mt

CONTENTS

Contents	1
List of Design Policies, Guidance and Standards	5
List of Figures and Tables	9
Glossary of terms	13
Preamble	26
Interim transitory provisions	27
PART 1	31
1.1 Document vision	31
1.1.1 The starting point – the need for good design	31
1.1.2 An urban design approach	33
1.2 Document scope – three objectives for good design	34
1.2.1 A contextual and street-based approach to design	34
1.2.2 Respecting the street as an important spatial scale – creating successful streets	36
1.2.3 Integrally-designed, energy-conscious, quality architecture	36
1.2.4 Translating the three objectives within the document	36
1.3 DC 15	38
1.3.1 How to use DC 15	38
1.3.2 Consolidation of other supplementary planning guidance, other key documents	40
1.3.3 A note on the illustrations used within the document	40
1.4 Development Planning Application submission requirements	41
1.4.1 The street photographic survey	42
1.4.2 The streetscape analysis	42
1.4.3 The design statement	42
1.4.4 Areas of Influence for street photographic survey, streetscape analysis, façade submission	43
PART 2 Contextual design	49
2.1 Local distinctiveness	49
2.1.1 Identification of Area Typologies	49
2.1.2 Contribution to the urban landscape	52
2.2 Natural features	53
2.3 Built features – streetscape character	56
2.3.1 Applying height to width ratio in Urban Conservation Areas	56
2.3.2 Relationship between new and existing buildings, transition design solutions	56
2.4 Built features – front, side and rear garden boundary walls	62
2.4.1 Front garden boundary walls	62
2.4.2 Side and rear garden/yard boundary walls	64
2.4.3 Front gardens – landscaping design	64
2.4.4 Front gardens used for driveways and carports	66
2.4.5 Front gardens in non-residential developments	66
2.5 Degree of activity – accessibility and movement	67
2.5.1 Access for all	67
2.5.2 Integration and accessibility of developments	67
2.5.3 Pedestrian access to non-residential developments	68

2.5.4	Vehicular access for all new developments	68
2.5.5	Access to and from arterial and distributor roads	70
2.5.6	Access to non-residential developments – vehicular access	71
2.5.7	Clear Access to Garages/Vehicular Accesses	71
2.5.8	Junctions and development accesses	72
2.5.9	Access for Fire Tenders	74
2.5.10	Waiting Areas	74
2.6	Degree of activity – parking areas and garages/vehicular accesses	74
2.6.1	Parking areas, parking spaces and garages	75
2.6.2	Headroom requirements	77
2.6.3	Underground Parking Areas – Domestic Stores	78
2.6.4	Parking provision and typology	78
2.6.5	Turning Space and Internal Circulation	79
2.6.6	Ramps – gradients, radii and widths	79
2.6.7	Garage door openings	81
2.6.8	Garages for private vehicles	82
2.6.9	Garages for private vehicles – detached and semi-detached dwellings	82
2.6.10	Garages for private vehicles – internal garages	83
2.6.11	Garages for Heavy Goods Vehicles and Public Service Vehicles	84
2.6.12	Garages for self-drive hire cars	85
2.6.13	Car Lifts	86
2.6.14	Landscaping in Parking Areas	87
2.7	Contextual design – Quality Checklist for periti, assessors and decision-makers	88
PART 3 Urban form		93
3.1	Urban grain and built form	93
3.1.1	Plot size	95
3.1.2	Plot considerations for detached and semi-detached dwellings	96
3.1.3	Minimum dwelling areas	102
3.1.4	Internal residential developments	103
3.2	Spatial enclosure – building line, façade proportion and building height	104
3.2.1	Building line	104
3.2.2	Façade proportion in terraced developments	105
3.2.3	Building heights	106
3.2.4	Building heights along sloping sites or streets	111
3.2.5	Building heights on corner sites	114
3.2.6	Building heights of non-residential developments	115
3.2.7	Higher than normal floors	115
3.3	Ground floor treatment	117
3.3.1	Basement levels	117
3.3.2	The design of active ground floor frontages	120
3.4	Setback floors and horizontal additions	121
3.4.1	Setback floors	121
3.4.2	Horizontal additions within side gardens – part of the dwelling or extensions	123
3.5	Urban form – Quality Checklist for periti, assessors and decision-makers	125

PART 4 Architectural quality	131
4.1 Neighbourhood amenity	133
4.1.1 Creation of, and access to, open spaces	133
4.1.2 Safety and security, design of spatial interfaces	135
4.1.3 Privacy between buildings	135
4.2 External appearance	137
4.2.1 Visual interest	137
4.2.2 Side and back elevations	137
4.2.3 Façade projections and setbacks	138
4.3 Development amenity and sustainable quality	142
4.3.1 Development amenity and internal layout	142
4.3.2 Sustainable quality	143
4.3.3 Provision of water reservoirs and second class water reuse	145
4.3.4 Photovoltaic Modules and Solar Water Heaters	145
4.3.5 Integrated design of sustainable materials and systems	146
4.3.6 Prevention of light pollution	148
4.4 The design of public buildings and non-residential developments	149
4.4.1 Designing public buildings and non-residential developments – design principles	149
4.4.2 Medium- to large-scale non-residential developments	150
4.4.3 Industrial developments	151
4.5 The design of shop fronts	152
4.5.1 Shop fronts – general design principles	152
4.5.2 Retention and replacement of existing shop fronts	153
4.6 Architectural quality – Quality Checklist for periti, assessors and decision-makers	155
PART 5 Architectural elements	161
5.1 Interpretation of, and alterations to, existing architectural elements and features	163
5.2 Secondary elements	165
5.2.1 Open Staircases	165
5.2.2 Applicability and design of fixed/demountable structures, canopies, awnings	167
5.2.3 The design of shop front elements	170
5.2.4 Cantilevers at roof level	173
5.2.5 Urban elements – trees and street furniture	174
5.3 Openings	178
5.3.1 General design principles for building openings	178
5.3.2 Design of apertures on façades	181
5.3.3 The design of apertures in shop fronts	182
5.4 Balconies	183
5.4.1 General design principles for balconies	183
5.4.2 Balcony projections	184
5.5 Services	187
5.5.1 General design principles for services	187
5.5.2 Chimneys/flues and fume extraction	190
5.5.3 Design for the integration and screening of services	191

5.6	Materials and finishes	195
5.6.1	General design principles for materials	195
5.6.2	Materials for building exteriors, elements, apertures and balconies	196
5.6.3	Materials for external paved surfaces	199
5.7	Colour	201
5.8	Architectural elements – Quality Checklist for periti, assessors and decision-makers	203
Annexes		207
Annex 1: Vehicle Parking Standards		208
Annex 2: Interpretation of Height Limitation		210

LIST OF DESIGN POLICIES, GUIDANCE AND STANDARDS

Ref.	Design Policy/Good-practice Design Guidance/Design Standard Title	Pg.
------	---	-----

Design Policies (P)

Part 2 – Contextual Design

P1	<i>Extent of commitment</i>	53
P2	<i>Topographical considerations</i>	54
P3	<i>Development on ridges</i>	56
P4	<i>Applying height to width ratio in Urban Conservation Areas</i>	56
P5	<i>Proposals for the rehabilitation or demolition of scheduled properties and properties within Urban Conservation Areas</i>	58
P6	<i>Transition design solutions</i>	59
P7	<i>Height of front garden boundary walls</i>	63
P8	<i>Side and rear garden/yard boundary walls</i>	64
P9	<i>Driveways, forecourts and carports</i>	66
P10	<i>Front gardens in non-residential developments</i>	66
P11	<i>Access for all</i>	67
P12	<i>Pedestrian access to non-residential developments</i>	68
P13	<i>Vehicular access for all new developments</i>	70
P14	<i>Access to and from arterial and distributor roads</i>	70
P15	<i>Vehicular access in Urban Conservation Areas</i>	72
P16	<i>Access for Fire Tenders</i>	74
P17	<i>Underground Parking Areas – Domestic Stores</i>	78
P18	<i>Parking provision and typology</i>	78
P19	<i>Residential garage door openings</i>	81
P20	<i>Garage door openings in Urban Conservation Areas</i>	81
P21	<i>Garages for private vehicles – general considerations</i>	82
P22	<i>Garages for private vehicles – detached and semi-detached dwellings</i>	82
P23	<i>Garages for private vehicles – internal garages</i>	83
P24	<i>Garages for Heavy Goods Vehicles and Public Service Vehicles</i>	84
P25	<i>Car Lifts</i>	86

Part 3 – Urban Form

P26	<i>Site frontage</i>	95
P27	<i>Depth of built footprint</i>	95
P28	<i>Detached and semi-detached dwellings</i>	98
P29	<i>Redevelopment of/into semi-detached dwellings</i>	101
P30	<i>Fully-detached multiple dwelling complexes</i>	101
P31	<i>Landscaping of detached and semi-detached dwellings</i>	102
P32	<i>Minimum dwelling areas and mix of dwelling sizes</i>	102
P33	<i>Internal residential developments</i>	103
P34	<i>Building line</i>	105

P35	<i>Building heights</i>	106
P36	<i>Building heights along sloping sites or streets</i>	111
P37	<i>Building heights of non-residential developments</i>	115
P38	<i>Basement levels – design and use</i>	117
P39	<i>Setback floors</i>	121
P40	<i>Horizontal additions within side gardens</i>	123

Part 4 – Architectural Quality

P41	<i>Privacy between buildings</i>	135
P42	<i>Side and back elevations</i>	137
P43	<i>Façade projections</i>	138
P44	<i>Façade setbacks</i>	141
P45	<i>Development amenity</i>	142
P46	<i>Refuse rooms</i>	142
P47	<i>Water reservoirs</i>	145
P48	<i>Integrated design of sustainable materials and systems</i>	146

Part 5 – Architectural Elements

P49	<i>Applicability of fixed/demountable structures, canopies and awnings</i>	167
P50	<i>Fixed and demountable structures, canopies and awnings – design parameters</i>	168
P51	<i>Balcony projections</i>	184
P52	<i>Designing for services</i>	187
P53	<i>Chimneys/flues, fume extraction</i>	190

Good-practice Design Guidance (G)

Part 2 – Contextual Design

G1	<i>Contribution to the urban landscape</i>	52
G2	<i>Visual impact of development</i>	52
G3	<i>Relationship between new and existing buildings</i>	58
G4	<i>Design of front garden boundary walls</i>	62
G5	<i>Front garden landscaping design</i>	65
G6	<i>Integration and accessibility of developments</i>	67
G7	<i>Vehicular access to non-residential developments</i>	71
G8	<i>Junctions and development accesses</i>	73
G9	<i>Parking areas – general design considerations</i>	74
G10	<i>Turning Space and Internal Circulation</i>	79
G11	<i>Obstruction of employee parking in non-residential developments</i>	79
G12	<i>Garages for self-drive hire cars</i>	85
G13	<i>Landscaping in Parking Areas</i>	87

Part 3 – Urban Form

G14	<i>Regard to existing urban grain and built form</i>	93
G15	<i>Exposed party walls due to setback</i>	105
G16	<i>Façade proportion</i>	105
G17	<i>Building heights on corner sites</i>	114
G18	<i>Higher than normal floors</i>	115
G19	<i>Active ground floor frontages</i>	120
G20	<i>Setback floors and horizontal additions</i>	121

Part 4 – Architectural Quality

G21	<i>Creation of, and access to, open spaces</i>	133
G22	<i>Safety and security, spatial interfaces</i>	135
G23	<i>Visual interest</i>	137
G24	<i>Internal layout and amenity spaces</i>	143
G25	<i>Design for energy conservation and resource management</i>	143
G26	<i>Photovoltaic Modules and Solar Water Heaters</i>	145
G27	<i>Prevention of light pollution</i>	148
G28	<i>The design of public buildings and non-residential developments</i>	149
G29	<i>Medium- to large-scale non-residential developments</i>	150
G30	<i>Industrial developments</i>	151
G31	<i>Shop fronts – general design principles</i>	152
G32	<i>Existing shop fronts</i>	153

Part 5 – Architectural Elements

G33	<i>Interpretation of, and alterations to, existing architectural elements/features</i>	163
G34	<i>Open staircases</i>	165
G35	<i>Allowance for permanently fixed and enclosed structures</i>	170
G36	<i>Shop front fascia</i>	170
G37	<i>Shop front illumination</i>	171
G38	<i>Shop front security shutters</i>	172
G39	<i>Shop front signs</i>	173
G40	<i>Cantilevers at roof level</i>	173
G41	<i>Trees and other landscaping</i>	174
G42	<i>Street furniture</i>	176
G43	<i>Openings – general design principles</i>	178
G44	<i>Design of apertures on façades</i>	181
G45	<i>Apertures in shop fronts</i>	182
G46	<i>Balconies – general design principles</i>	183
G47	<i>The integration and screening of services</i>	191
G48	<i>Materials – general design principles</i>	195
G49	<i>Materials for building exteriors</i>	196
G50	<i>Materials for apertures, balconies and elements</i>	197

G51	<i>Materials for external paved surfaces</i>	199
G52	<i>Designing for colour</i>	201

Design Standards (S)

Part 2 – Contextual Design

S1	<i>Vehicular access width standards</i>	68
S2	<i>Clear access width standards for garages</i>	71
S3	<i>Standards for waiting areas</i>	74
S4	<i>Standards for parking areas, parking spaces and garages</i>	75
S5	<i>Headroom standards in parking environments</i>	78
S6	<i>Ramp standards – gradients, radii and widths</i>	79

Part 4 – Architectural Quality

S7	<i>Privacy standards</i>	136
-----------	--------------------------	------------

LIST OF FIGURES AND TABLES

List of Figures

Fig. No.	Figure Title	Pg.
1	<i>Awnings</i>	13
2	<i>Basement Types</i>	14
3	<i>Canopies/shading devices</i>	15
4	<i>Lightweight tented structure and timber pergola</i>	16
5	<i>Open (left) and predominantly enclosed (centre) porch and portico (right)</i>	16
6	<i>Height to width ratio</i>	17
7	<i>Façade and aperture rhythm along a streetscape</i>	19
8	<i>Typical ridge edge in Gozo</i>	20
9	<i>Side curtilage</i>	21
10	<i>Solid to void ratio</i>	22
11	<i>Streetscape qualities and analysis</i>	23
12	<i>Urban grain</i>	25
13	<i>The inter-relationship of spatial scales</i>	33
14	<i>Respecting the context – what it does not mean</i>	34
15	<i>Creating successful streets</i>	37
16	<i>Policy/regulation, Good-practice guidance and Technical standards</i>	38
17	<i>The proportion of Policy/regulation, Good-practice guidance and Technical standards within Parts 2, 3, 4 and 5 of DC 15</i>	39
18	<i>Areas of Influence for street photographic survey/building height analysis, streetscape analysis, façade submission</i>	44
19	<i>Part 1 – Key messages</i>	45
20	<i>Contributors to setting, local distinctiveness and streetscape – the remit of Part 2 is highlighted</i>	50
21	<i>Area Typologies dealt with within DC 15</i>	51
22	<i>Area Typologies denoted within DC 15</i>	52
23	<i>Landscape and topographical variations</i>	53
24	<i>Development massing along a ridge edge</i>	55
25	<i>Contemporary development within an existing urban area</i>	57
26	<i>Transition design solutions – 3 scenarios</i>	61
27	<i>Well-proportioned front garden boundary walls</i>	62
28	<i>Existing front gardens providing street rhythm</i>	63
29	<i>The contribution of well-landscaped front gardens</i>	65
30	<i>Vehicular access width standards</i>	69
31	<i>Clear access width standards for garages</i>	72

32	<i>Junctions, corners and bends – possible scenarios</i>	73
33	<i>Different aspects of Parking Layouts</i>	75
34	<i>Radii and swept paths diagram</i>	77
35	<i>Absolute Minimum Dimensions for Helical Ramps</i>	80
36	<i>Garage within the side curtilage</i>	83
37	<i>Landscaped surface parking area (left); car parking shading structures that double up as energy-generators (right)</i>	87

38	<i>Contributors to setting, local distinctiveness and streetscape – the remit of Part 3 is highlighted</i>	94
39	<i>Depth of built footprint (a) with existing adjacent legal buildings on either side and (b) with only one existing legal building</i>	96
40	<i>Well-designed semi-detached dwellings</i>	97
41	<i>Redevelopment of semi-detached dwelling – design considerations</i>	100
42	<i>New developments should be seen as an opportunity to increase permeability within urban areas</i>	104
43	<i>Façade rhythm resulting from façade proportions in terraced development</i>	106
44	<i>Calculating the correct façade proportion</i>	106
45	<i>Acceptable (left) and unacceptable (right) design solutions for the 1m roof parapet wall above setback floor</i>	107
46	<i>Determination of setback for uppermost floor for a street façade of 12m, 14.1m and 21.6m and a building line-to-building line distance of 8.5m, 10.34m, 13.34m and 16.34m</i>	108/109
47	<i>Interpretation of building height limitations for villa/bungalow areas</i>	110
48	<i>Determination of setback in the case of buildings facing open areas (piazzas and countryside) or for seafront buildings</i>	111
49	<i>Development of site between two streets located at different levels – except villa and bungalow areas</i>	112
50	<i>Development of infill terraced developments located on a sloping street</i>	113
51	<i>Corner site designs</i>	114
52	<i>Well-designed development having higher than normal floors</i>	116
53	<i>Semi-detached villa located on sloping terrain containing a basement level</i>	119
54	<i>Well-designed active frontages</i>	120
55	<i>Setback floor being served by lift – design considerations</i>	122
56	<i>Horizontal additions within side gardens – key design parameters</i>	124

57	<i>Contributors to setting, local distinctiveness and streetscape – the remit of Part 4 is highlighted</i>	132
58	<i>Well-designed open spaces provide an important asset to urban environments</i>	134
59	<i>Privacy standards</i>	136
60	<i>If well designed, a projecting façade may provide a positive contribution to the built environment</i>	139
61	<i>Façade projection – quantitative considerations</i>	140

62	<i>Well-designed façade setbacks that may create an interesting architectural treatment (top) and quality outdoor spaces at ground floor (bottom)</i>	141
63	<i>Integrated energy conservation measures within buildings</i>	144
64	<i>Inclined roof to take PV modules (left) and SWH collectors (right, option shown for a passive system)</i>	147
65	<i>Options for PV modules and SWH collectors mounted on a flat roof</i>	147
66	<i>Public and non-residential building – good design</i>	149
67	<i>Public and non-residential building – good detailing</i>	150
68	<i>Shop fronts offer an important contribution to the shopping street and its surrounding context</i>	153
69	<i>Retrofitting an existing commercial premises including existing shop fronts</i>	154

70	<i>Contributors to setting, local distinctiveness and streetscape – the remit of Part 5 is highlighted</i>	162
71	<i>Well-crafted addition to existing building, reflecting original architectural elements</i>	164
72	<i>Successful contemporary addition and alterations to existing building</i>	164
73	<i>Positive contribution of open staircase to architectural composition</i>	166
74	<i>Canopy/shading device (left) and retractable awning (right) deployed on the façade of buildings</i>	169
75	<i>Awnings – key design parameters</i>	169
76	<i>Well-designed shop front fascias</i>	171
77	<i>Well-designed shop front illumination</i>	172
78	<i>Well-designed (left) and poorly detailed (right) shop front security shutters</i>	173
79	<i>Roof cantilevers</i>	174
80	<i>Trees provide an important qualitative contribution to the built environment</i>	174
81	<i>Well-designed landscaping schemes improve the amenity value of urban areas</i>	175
82	<i>Street furniture enriches the quality of urban spaces through its visual, functional and social contributions</i>	177
83	<i>An interpretation panel (bottom left) and commemorative plaques (top left, right)</i>	177
84	<i>Key design considerations for openings include their positioning, orientation, rhythm/organisation and proportion/sizing</i>	179
85	<i>Openings located on buildings within older village cores are typically characterised by symmetrically positioned vertical openings organised in horizontal bands and a high solid: void ratio</i>	180
86	<i>The sense of solidity characterising tight-knit urban areas is also due to a high solid: void ratio</i>	180
87	<i>Key quantitative criteria for apertures on façades</i>	181
88	<i>Well-designed and proportioned shop front apertures</i>	182
89	<i>Valletta is characterised by the interesting rhythm provided by both open and closed balconies</i>	183
90	<i>Open balcony projection for existing streets</i>	185

91	<i>Closed balcony projection for existing streets</i>	186
92	<i>Maximum balcony projection over side curtilage</i>	187
93	<i>Visual clutter on roofscapes due to the sporadic location of services</i>	188
94	<i>Opportunity exists to design the roof capping in innovative ways</i>	189
95	<i>Screening of services at roof level</i>	193
96	<i>Services located at roof level – different possible scenarios with screening requirements</i>	194
97	<i>Choosing a good material palette comprises an important stage in the design of a development</i>	195
98	<i>Interesting use of materials within the urban fabric</i>	196
99	<i>Building exteriors in Urban Conservation Areas</i>	197
100	<i>Contemporary materials deployed within medium-scale developments</i>	197
101	<i>An interesting use of materials for different aperture typologies</i>	199
102	<i>Aperture materials within Urban Conservation Areas demand an in-depth study</i>	199
103	<i>The use of high-quality materials in the paving of external environments is of utmost importance</i>	200
104	<i>Heritage Buildings Traditional Colour Palette</i>	201
105	<i>Interesting (left) and undesirable (right) illustrations of colour deployment within the urban fabric</i>	202

List of Tables

Table No.	Table Title	Pg.
1	<i>Central Government objectives for DC 15</i>	32
2	<i>Typical Parking Space Requirements</i>	76
3	<i>Recommended Parking Dimensions for communal car parking areas</i>	76
4	<i>Recommended Minimum Parking Dimensions for Garages in Residential Developments</i>	76
5	<i>Detached and semi-detached dwellings – required standards</i>	98/99
6	<i>Applicability of fixed, demountable structures, canopies and awnings</i>	167

GLOSSARY OF TERMS

active frontage refers to the frontage of a building (or its front garden interface as may be applicable) at street level that provides a pleasant, interesting and positive contribution to the street context within which it is located and, consequently, enriching the pedestrian experience within such street. Active frontages are achieved through the careful design and articulation of façades and the apertures contained therein. Conversely a **dead frontage** is one that offers little or no contribution to the street, such as blank walls or street-level garages.

amenity refers to the comfort, convenience, pleasantness, safety, security and utility that may be enjoyed within and around a property, street or neighbourhood. The achievement of amenity translates into physical interventions; examples include: the definition of privacy distances, the creation of buffer zones and the design of property interfaces in order to avoid issues of overlooking or to guarantee an element of safety against crime; design that allows a good amount of daylight to penetrate internal spaces or a good level of outlook that may be enjoyed by a property so as to guarantee a sense of pleasantness to its users; or the location, proximity and compatibility of different land uses, in order to avoid or minimise the impact of unpleasant noises or odours being generated.

architectural quality refers to the qualitative totality of architectural design, which follows on from established parameters in relation to urban form and primarily includes issues in relation to external appearance (architectural expression/language, visual interest, innovation and creativity, appropriateness of architectural ambition), amenity, energy-conscious design, architectural detailing, integral architectural design, and façade composition including the contribution of architectural elements and features.

aspect means the direction in which a development faces, thus 'single-aspect' implies that such development faces only one direction and so has windows looking out in that direction.

awning (or overhang) is a retractable covering attached to a building's façade, usually comprising a woven fabric stretched over a lightweight structure that includes a mechanism allowing for it to extend and retract as and when required (**Figure 1**).



Figure 1: Awnings

basement is any level, the finished floor of which partly occurs below finished pavement level measured from such pavement taken at the highest street level until the underside level of the slab. There may be three types of basement levels (**Figure 2(a), (b) and (c)**). For existing developments, a level which has a finished floor which is not lower than 0.6 metres below the pavement level will still be considered as a ground floor (**Figure 2(d)**).

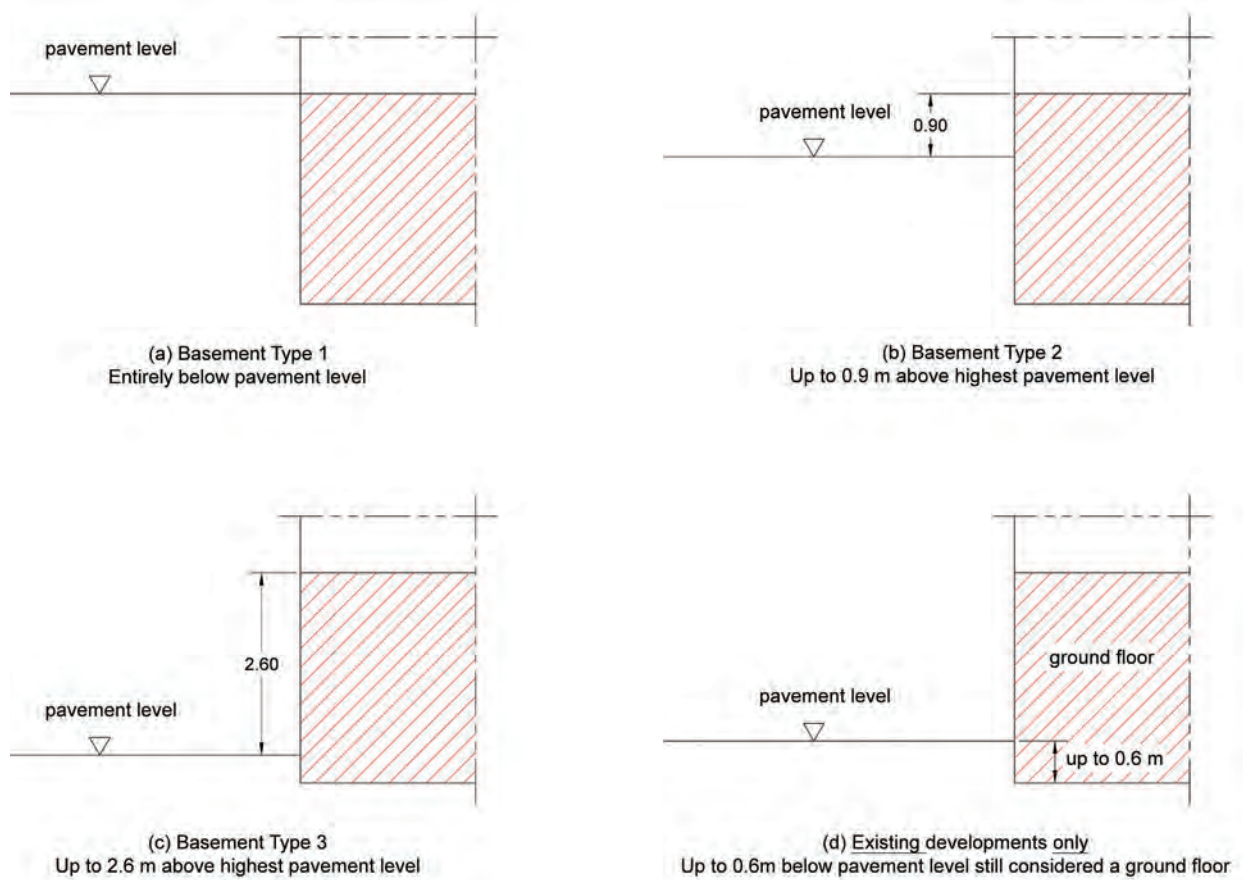

Figure 2: Basement Types

buffer (or buffer zone) means a physical and visual separation between different developments/uses in order to: either (a) mitigate the impacts of noise, smells, light, or other nuisance that would otherwise be detrimental to the amenity of one or more of the surrounding developments; or (b) safeguard the users of a specific development in terms of safety and/or security considerations. It may take the form of an open space, a landscaped area, an embankment, a fence, a wall, or any combination thereof as appropriate to the specific context in question.

building envelope (or building bulk or building volume) means the volumetric form of the building as contained by its outer planes, that is the front, rear and side walls, and roof(s) of the building.

building frontage is the allowable width of a building measured along its façade that may be parallel to and either setback from (in the case of front gardens) or abutting (if no front gardens are present) the public pavement or street. When neighbouring properties abut the building in question (in the case of terraced or semi-detached developments) the building frontage is measured until the centre-line of the common party wall separating the two properties.

building height is the maximum allowable distance in metres, measured vertically from the finished pavement level up to the top of the roof parapet wall of additional setback floors taken at the highest road level, established within the Local Plans. In the case of shared space urban environments (that is, urban environments having a common, uniform surface used by both pedestrians and vehicles) the pavement level will equate to the finished official road level itself.

canopy (or shading device) is an overhead structure or projection fixed directly to, and supported from, the façade of a building *without* the inclusion of uprights (vertical elements or posts) (**Figure 3**).



Figure 3: Canopies/shading devices

carport is a covered structure built to offer limited protection to a motor vehicle that has a minimum of fifty per cent of the total area of its sides open.

character means the unique qualities of a street, neighbourhood, district or settlement that together contribute to its identity and local distinctiveness and that are often defined and shaped by history. It comprises physical aspects such as the built/urban typologies, specific routes and connections, natural features, levels and topography, building materials and features, as well as important socio-economic and socio-cultural considerations (such as demographics and land uses).

context means the bigger setting within which a project/development is to be located, ranging from the immediate street environment to the urban settlement at large, which is affected and impacted upon by such development to varying degrees (depending on the scale of the proposed development).

demountable structure means a lightweight, easily-reversible structure that is ancillary to the more permanent building structure (**Figure 4**). It may take the form of a:

- **lightweight tented structure** – a structure having a covering (generally made of plastic or fabric) supported by a structural mechanism such as poles, beam/column, or cables; or
- **pergola** – a structure that consists of uprights (vertical elements or posts), beams and rafters, which may be entirely open or partially enclosed (up to fifty per cent of the total area of its roof and sides) using an open trelliswork design.



Figure 4: Lightweight tented structure and timber pergola

Sources: (left) <http://zeointerior.com/patio-gazebo-pictures.html>; (right) <http://www.archiexpo.com/prod/groupe-grad/wooden-pergolas-99392-1003607.html>

dwelling encapsulates different residential typologies, including flats, maisonettes, terraced houses, semi- and fully-detached villas and bungalows, although its precise meaning is defined according to the specific context wherein it is used. Particular policies may therefore exclude certain forms of dwelling or refer only to a specific dwelling typology (or a limited number thereof).

fixed structure means a covered, permanent structure, containing vertical supports, which projects from the façade of a building (**Figure 5**). It may take the form of a:

- **porch** – a projection which generally defines the entrance to a building and may be predominantly enclosed on its sides by means of solid elements; or
- **portico** – an extension along and projection beyond the wall of the building, which is supported by columns and is therefore only partially enclosed on its sides.

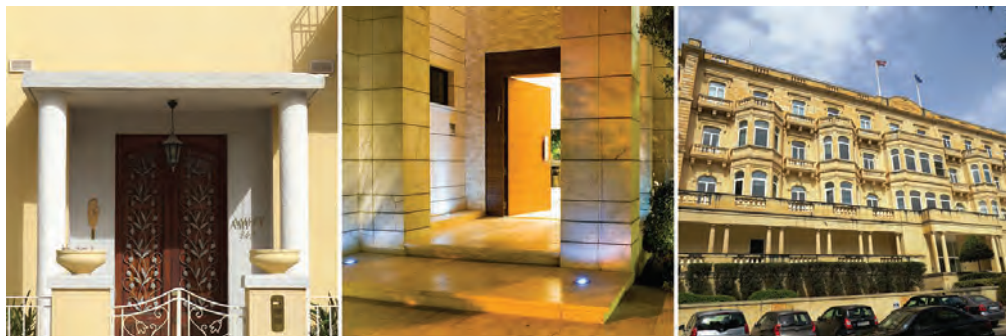

Figure 5: Open (left) and predominantly enclosed (centre) porch and portico (right)

Source: (centre) <http://nhenrisk.org>

Gross Floor Area (GFA) of a development is the total area of the whole unit measured from the external face of the development's walls (or in the case of party walls measured up to half the width of such walls), including all internal and usable external spaces, such as balconies and terraces, which go beyond the statutory sanitary requirements and excluding the net area of any service shafts contained within such development. In the case of usable external spaces, the floor space which shall be considered as part of the minimum dwelling size shall not exceed 10% of the established threshold for the relevant dwelling size.

heavy goods vehicle is a vehicle (such as a van, lorry, bus or coach) having a Gross Vehicle Weight of 3500kg or more, used for (or in connection with) a trade, business or occupation.

height to width ratio refers to the relationship between the building height and street width. It is calculated by dividing the building height 'h' by the street width 'w', calculated as the clear horizontal distance between two opposing building frontages, and expressing the resultant ratio in the form of 1:x (building height:street width) (**Figure 6**). Height to width ratio does not apply in the case of seafront developments and developments fronting ODZ.

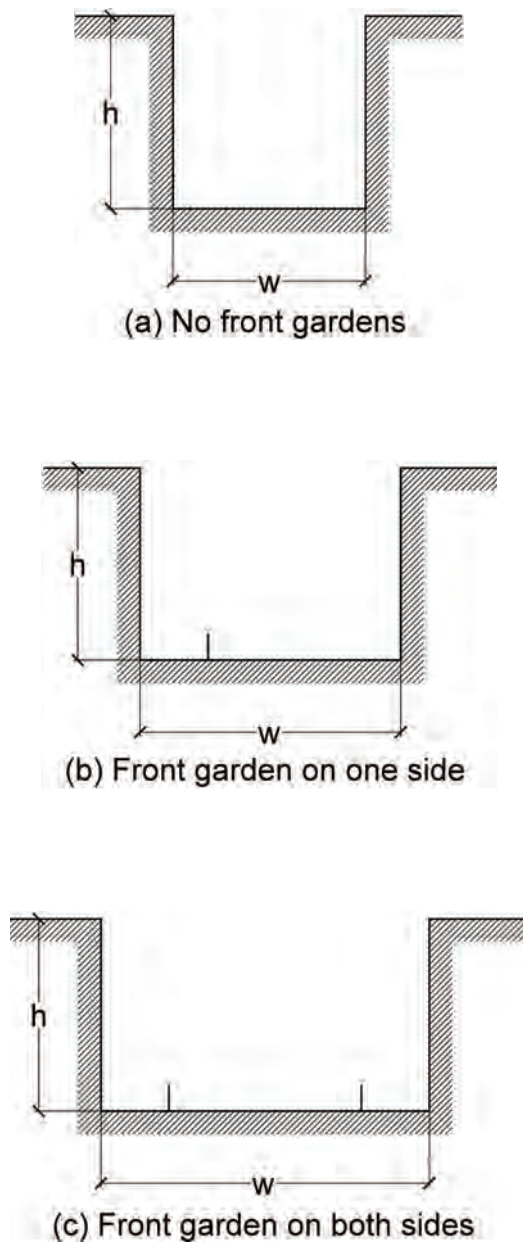

Figure 6: Height to width ratio

heritage building is an immovable asset of cultural, aesthetic, architectural, artistic, historical, social, scientific/research, industrial, contextual or representative value/s. Normally such a building is of a particular age, however it may also be contemporary if any of the building's inherent values are deemed to be worth preserving.

human scale refers to the scale of the human figure relative to the scale of the built fabric. Due regard must be given to the human eye height, which is generally averaged out to 1.6m and the human angle of vision which is taken to be between 50-55 degrees. Together these two aspects have a strong bearing on ideal height to width ratios such that the built fabric does not unduly dominate or overshadow pedestrian spaces and its form, shape and materials do not create a feeling of uneasiness or of a lack of safety for pedestrians.

internal garages/vehicular accesses means a group of garages/vehicular accesses arranged around an open garage court or other open space (entirely open or roofed), having a single access onto the adjoining street. Such garages/vehicular accesses are usually located at the rear of other existing developments on what may be termed backland sites.

Internal residential development means residential development which takes place on land: (a) located behind a developed area (backland) or (b) where one or more dwelling units are without a frontage onto a schemed road. Residential schemes created through the application of the Floor Area Ratio (FAR) Policy are to be assessed according to the provisions of the policy document *A Planning Policy Guide on the Use and Applicability of the Floor Area Ratio (FAR)* and not the provisions of this document.

microclimate is the local climate of specific indoor and outdoor areas, as well as that of the spatial interfaces between such areas and it is primarily affected by issues in relation to sunlight penetration and wind movement.

multiple dwellings are units which share a common entrance within the same block.

outlook (or visual access) refers to the visual aspect that may be enjoyed when looking outwards through a building's aperture other than, or beyond, a restricted distance from such aperture. This may include, but is not limited to, a view or vista.

plot frontage (or site frontage) is the portion of a plot/site that abuts a schemed road from which primary access to the development will usually occur. It is measured between the centre-lines of the two common party walls that separate the plot/site from adjacent ones.

private vehicle means a car, van, motorcycle or other vehicle used by a private individual for personal transport but not for a trade, business or occupation.

public road is a road established within the Local Plans or through a Planning Control (PC) application, or any road that is maintained by the Local Council or the transport Authority wherein the public has free, unencumbered and unrestrictive access and having a width defined by the transport Authority regulations.

public service garage means a garage for vehicles used for hire or for the provision of a private or public transport service (including buses, mini-buses, taxis and self-drive hire cars).

public space means any area to which the public at large has free and unrestricted access, including urban spaces such as streets and squares, landscaped and recreational open spaces.

rehabilitation means the physical improvement necessary to provide an appropriate use to a vacant or inappropriately utilised structure to contemporary functional standards. Rehabilitation should always aim towards reuse that is close as possible to the original function so as to ensure a minimum intervention and minimum loss of cultural values; this also makes sense economically, but may also involve adaptation for new use.

residual site refers to the resultant area following the parcelling of plots by virtue of a public deed as occurring prior to the issue of this document, which will not result in the creation of more than two non-flatted residential units.

restoration aims to conserve the integrity of the heritage item as well as to reveal its cultural values and to improve the legibility of its original design. It involves the recovery of a building or structure, or part of it having heritage value, to an earlier known state on the guidance of International Conventions and Charters on the subject. Restoration is achieved by means of documentation and the study of the building's authenticity and its materials which have decayed or have been damaged; by the repair of the existing fabric through the removal of inappropriate past interventions; by reassembly and reinstatement through approved techniques and materials; and by improving the endurance or by reducing the deterioration of any heritage building. Such action should avoid significant loss of authenticity in materials and craftsmanship as far as possible.

rhythm is the arrangement and size of the different parts or elements of a façade, such as apertures, generally creating a sequential pattern along a given streetscape (**Figure 7**).



Figure 7: Façade and aperture rhythm along a streetscape

ridge edge means the edge of a hill or plateau, where relatively flat or gently sloping land gives way to a valley side or hill-side, escarpment, cliff or other comparable distinct slope. A drop in terrain of 3 metres or more constitutes a ridge (**Figure 8**).



Figure 8: Typical ridge edge in Gozo

roof structures include internal stairwells, washrooms, residential rooms, lifts and lift rooms, plant rooms and other structures located at the roof level of a building. It excludes Wind Turbines (as defined within the *Micro Wind Turbines Policy*), Telephony/Communication Antennae and flagpoles.

semi-private space refers to that space that is privately owned and wherein physical public access is generally precluded (unless desired by the private owner). Nonetheless some limited form of public interaction may still be allowed, such as visual access. Front gardens are considered to be semi-private spaces.

semi-public space refers to that space that has a certain degree of public ownership and that may be accessed by the public to a limited degree, due to restrictions in the form of payment for access or usage of space or due to a predominant function within the space that precludes certain forms of public interaction or activity.

setback is the horizontal parallel distance required between a development and the building alignment, measured at right angles to such line. A setback floor is the horizontal parallel distance measured from any underlying building line to the receded structure, measured at right angles to this distance.

side curtilage (Figure 9) means the clear distance between the outer skin of the nearest wall of the building and the:

- nearest face of the boundary wall dividing properties; or
- outer face of the boundary wall directly abutting a public or private street/road.

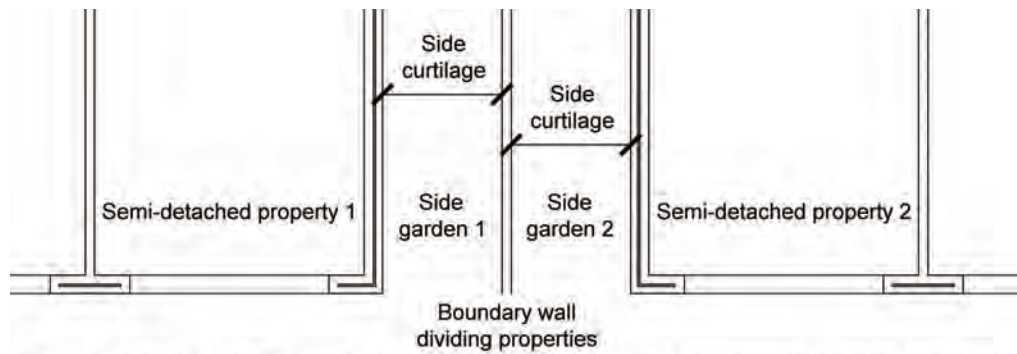

Scenario 1: Side curtilage with boundary wall dividing properties – clear distance to nearest face of boundary wall

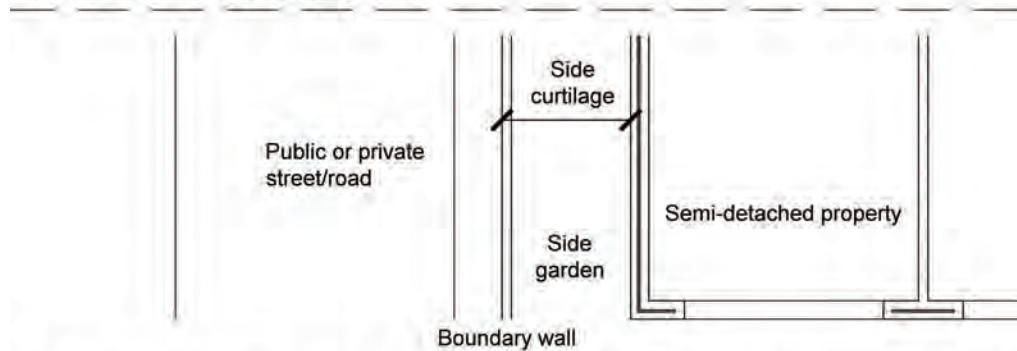

Scenario 2: Side curtilage with boundary wall directly abutting a public or private street/road – distance to outer face of boundary wall

Figure 9: Side curtilage

site clearance means the preparation of the site for development and thus includes, according to the nature of the site: (a) the removal of top soil and vegetation; and (b) the demolition or removal of any buildings or structures on the site.

site coverage is the total area of a site that is covered by the principal building and any ancillary fixed structures, excluding carports and garages and any area occupied by demountable structures and canopies. It is therefore calculated by dividing the total area of the ground floor of the principal building and any ancillary fixed structures, measured from the external face of the development's walls (or in the case of party walls measured up to half the width of such walls) and including all spaces contained therein, by the total site area and expressing this ratio as a percentage.

solid to void ratio refers to the relationship between the 'solid' component, that is, the built area of a building's façade and the 'void' component, that is, the total perforated area of a building's façade due to openings. It is calculated by dividing the solid area by the void area (both in square metres) and expressing the resultant ratio in the form of 1:x (solid:void) (Figure 10).

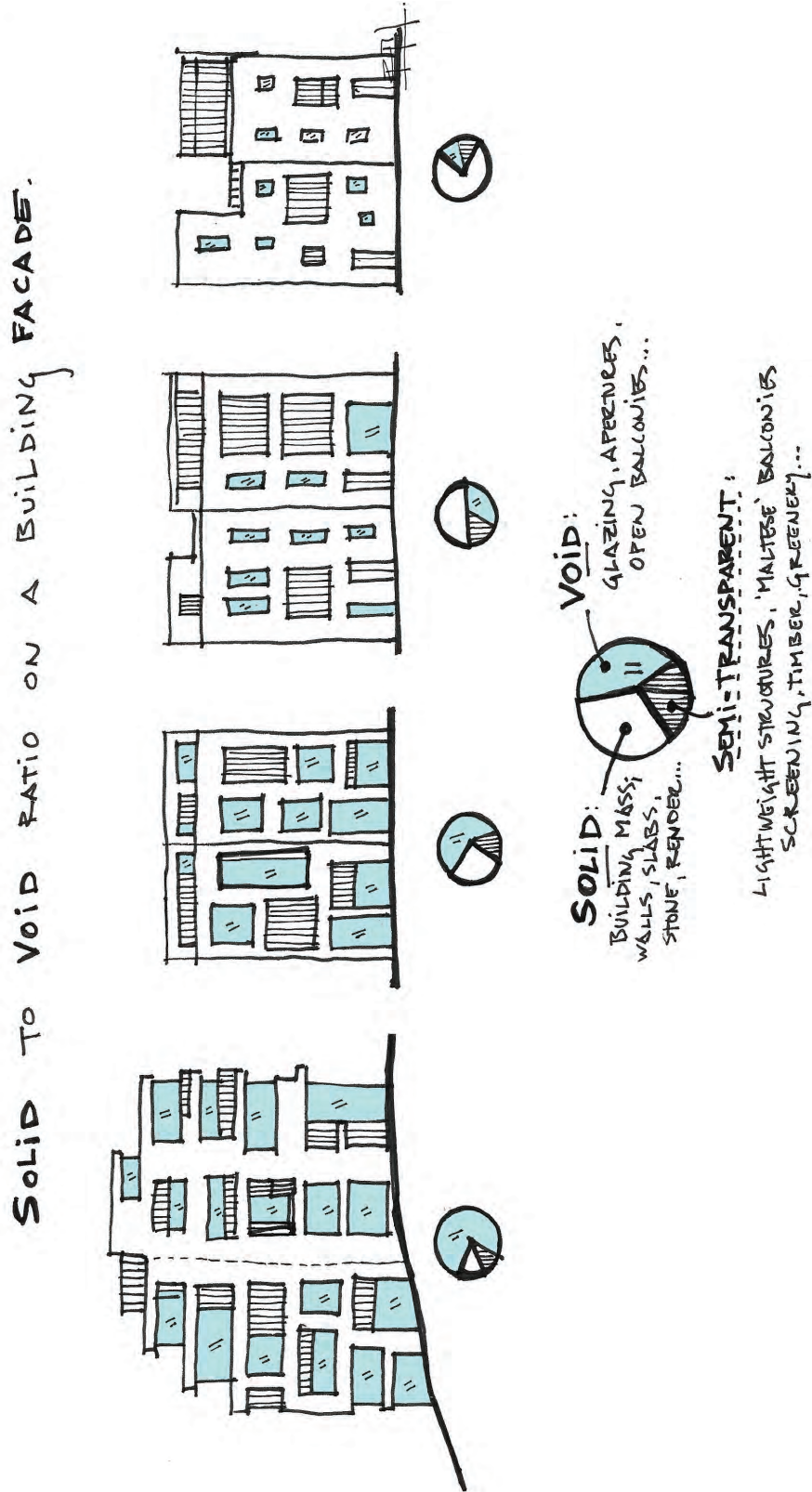

Figure 10: Solid to void ratio

street is a continuously linked, open, three-dimensional public or controlled space providing a frontage to property through which proper vehicular or pedestrian access may be obtained. It may or may not contain a vehicular road. The character of a given street, defined by its physical composition in terms of spatial quality, the buildings that enclose and frame the street space and other elements (such as landscaping and urban furniture) is defined by the term **streetscape** (Figure 11), and the above may be studied through a streetscape analysis that may also include a façade analysis (an analysis of the façade elements and characteristics that define the enclosure of the given street).

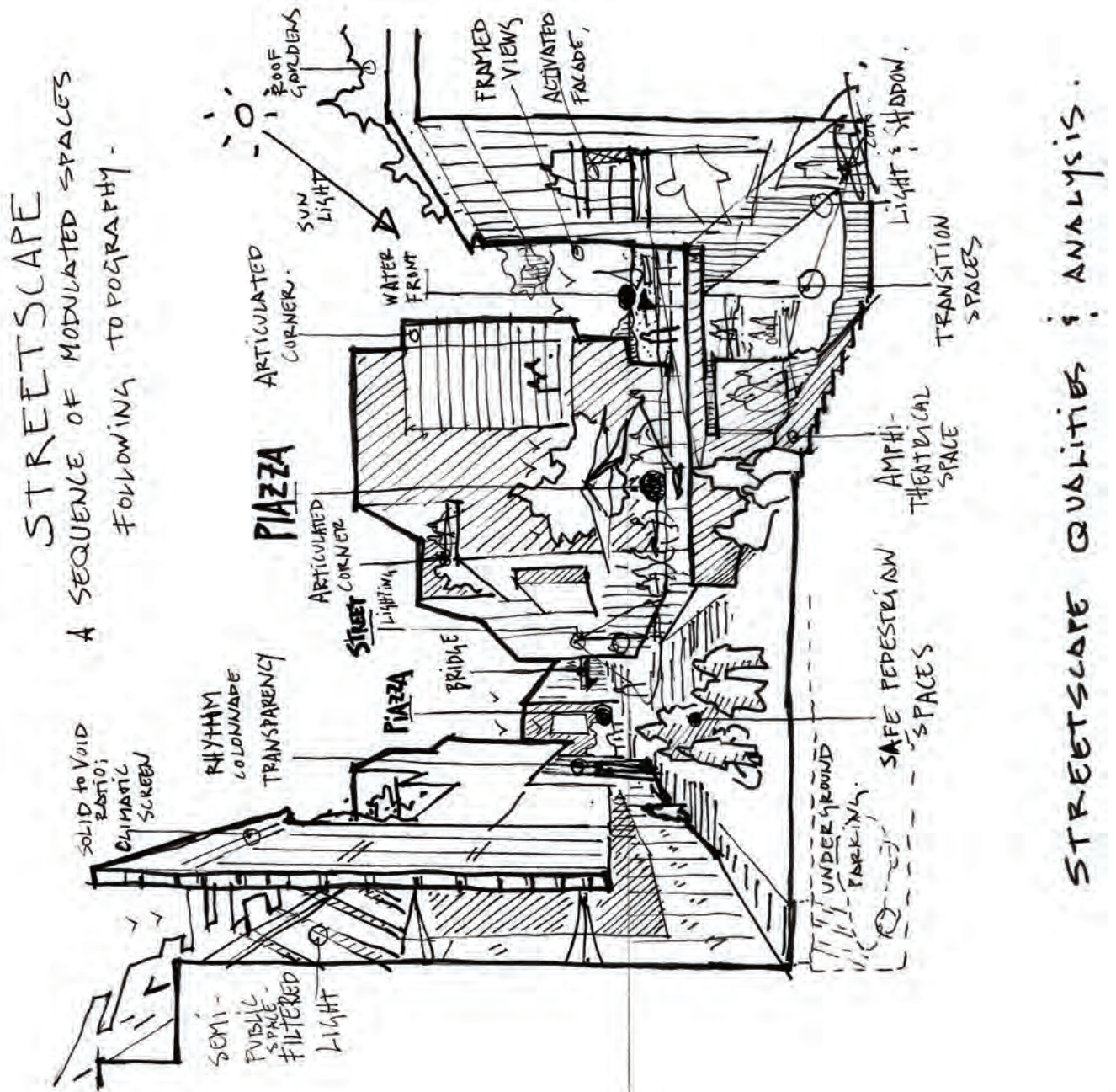

Figure 11: Streetscape qualities and analysis

street furniture includes elements that have an important functional and visual/aesthetic role in terms of the overall street setting. This includes seats/benches, street lighting, bus shelters, raised planters, information signs, traffic signs, railings, bollards, post boxes, litterbins, telephone booths, clocks, plaques and monuments (including commemorative plaques and interpretation panels).

Student Priority Areas are defined as those areas within the development zone, but excluding villa and bungalow areas contained within a band not exceeding 350m width (broadly equivalent to a 5-minute walk) around the external perimeter of the following institutions – University of Malta; Junior College; MCAST campuses located in Naxxar, Paola and Msida; Mater Dei Hospital and Gozo General Hospital.

townscape means the landscape of the urban setting, comprising both buildings and urban spaces as well as five types of interrelationships: (a) among individual buildings; (b) between buildings and different typologies of urban spaces (which in turn are enclosed and framed by buildings); (c) among different urban spaces; (d) among individuals and buildings; and (e) among individuals and urban spaces, particularly as these are perceived during movement through a specific urban area. The streetscape (defined separately) is a key component of townscape.

urban grain is the established pattern of built form, including plot divisions, within an urban settlement (**Figure 12**).

urban space is defined as the 'in-between' land subdivision (the blocks/plots) and the built form (the individual buildings). It primarily comprises streets and squares.

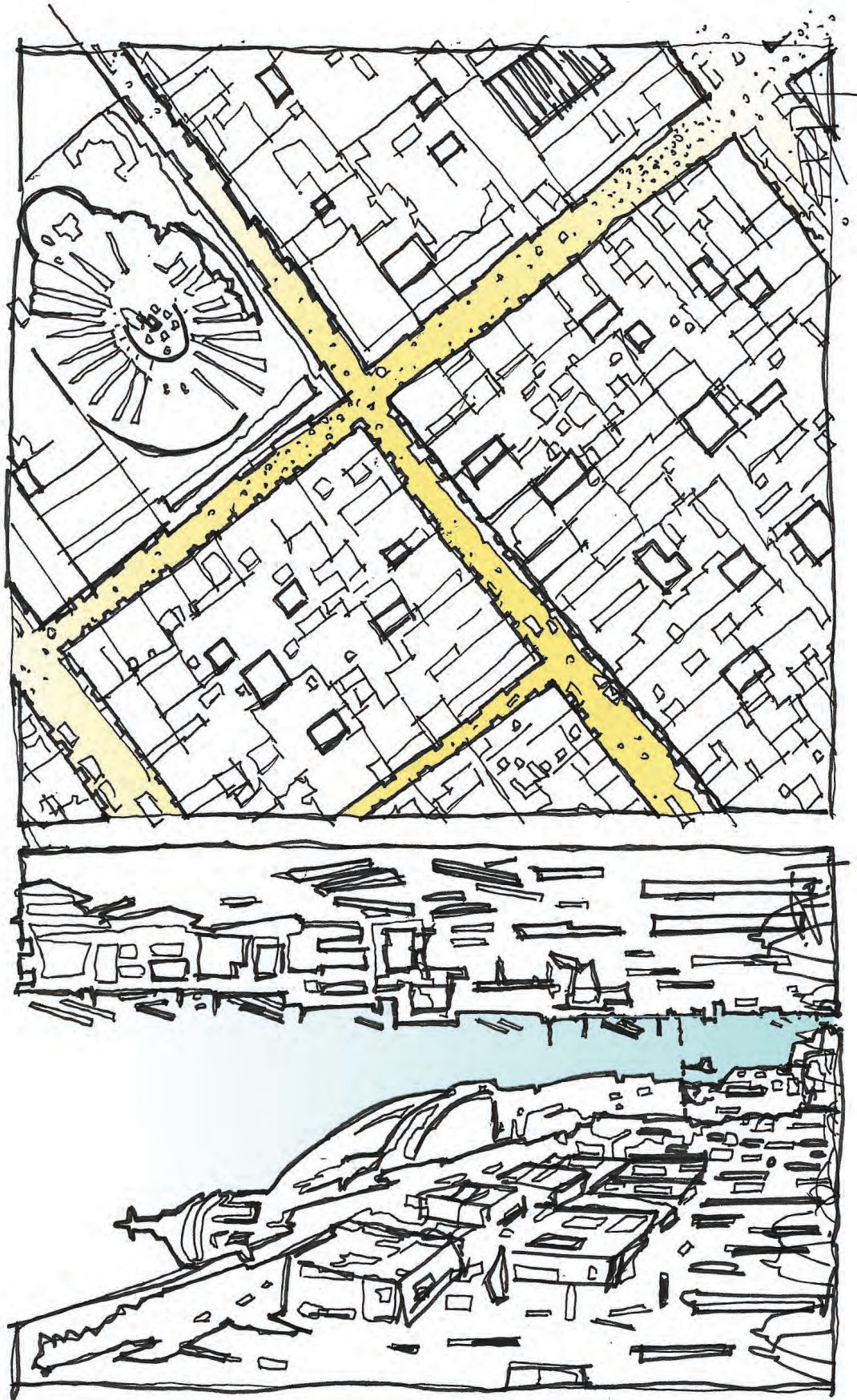

URBAN GRAIN.

Figure 12: Urban grain

PREAMBLE

Development Control Policy, Guidance and Standards 2015 (DC 15) is a collective commitment towards good design in our built environment. It is the result of a collaborative process led by the Malta Environment and Planning Authority (MEPA) and involving academia, practising periti, decision-makers and experts in the fields of sanitary law, transport and conservation.

This is a positive document, based on the recognition that there are some important, basic, parameters that must be clearly established in order to guarantee the formation of successful streets and thus establishes 'context' as the leading principle in design, assessment and decision-making of any development proposal. At the same time, it acknowledges that contexts differ and that 'one-size-fits-all' solutions are not always applicable, or indeed desirable. The document's role is also to enable innovative and creative urban and architectural designs that are framed within the important urban design parameters, which in turn are tailor-made to the unique Maltese territory, its urban areas and landscape.

The formulation of DC 15 has been equally informed by urban design and architectural theory, 'on the ground' practice and the wealth of experience gained along the years in policy-making and decision taking. A significant effort has been made to correct any vague or unclear definitions, statements and policies present within Development Control Policy and Design Guidance 2007 (DC 07), also through the experience of the document's implementation in practice over the past eight years. Qualitative and quantitative considerations have been placed on an equal footing and, in some cases, qualitative performance criteria are given more weight than quantitative standards.

However the document is not merely a revision of DC 07 – DC 15 constitutes a new direction in terms of urban and architectural design policy, guidance and standards. Within the document there is a clear departure from a single typology of policy provision to a new framework composed of policy, good-practice guidance and technical specifications. Illustrations selected from both local and foreign contexts are meant to clearly demonstrate the intended spirit of individual document provisions and to further promote the achievement of good design on the ground.

Through the above considerations, it is hoped that DC 15 may encourage and stimulate urban and architectural design that is respectful of, and that enriches, its existing context while also being forward-looking, quality-oriented and energy-conscious.

Dr Antoine Zammit PhD, perit

INTERIM TRANSITORY PROVISIONS

In the interim period pending the approval of the Local Plans, Policies P4, P27 and P32 will prevail over the Local Plans, unless there is conflict with site-specific policies within a locality in which case the Local Plans will prevail. Development planning applications will otherwise be assessed according to the provisions of the Local Plans.

Height limitations in metres will now be governed according to the interpretation provided in Annex 2.

Any development planning application that is validated following the coming into force of this document shall be assessed according to the provisions of DC 15. Any development planning application validated prior to the coming into force of this document and still being processed shall be assessed in line with DC07, unless the applicant (or architect) requests that DC 15 be used in the assessment of the application.

Furthermore, with regard to those applications which are/have not been deferred for a decision by the Environment and Planning Review Tribunal (EPRT) on the date of coming into force of this document, the applicant shall be requested by the EPRT to indicate whether DC07 or DC 15 will be used in the determination of the appeal.



AUBERGE D'ARAGON
ST PAUL'S ANGLICAN CATHEDRAL
OUR LADY OF PILAR CHURCH

CONCERTS
ST PAUL'S

01

- 1.1** DOCUMENT VISION
- 1.2** DOCUMENT SCOPE – THREE OBJECTIVES FOR GOOD DESIGN
- 1.3** DC 15
- 1.4** DEVELOPMENT PLANNING APPLICATION
SUBMISSION REQUIREMENTS

1.1 DOCUMENT VISION

1.1.1 The starting point – the need for good design

The attainment of urban and architectural design quality is an integral objective of DC 15. Our urban environment cannot afford to have a low-quality built fabric – a fabric that produces bland, repetitive blocks that are discordant with the older components of the street and, in the worst cases, kill the spirit of our streets due to the negative impact that is created in visual, social and environmental terms; a fabric characterised by dead façades, blank walls and exposed services that scar our townscapes, streetscapes and skylines; a fabric that is wasteful on land and energy resources without seeking to minimise this impact by providing a positive contribution in energy terms; a fabric that does not consider the consequences it might have on the neighbouring residential amenity.

High-quality design is very often a site-specific solution that must be worked within the specificities of context. This is not to say that some universal principles, policies and standards cannot or should not be established, but that urban and architectural design considerations apply to different degrees, depending on the particularities and sensitivity of such contexts. Indeed DC 15 signifies a departure from having policies that are given the same weight and instead distinguishes between different qualities and elements that comprise urban and architectural design, while furthermore elevating the role of context in the approaches to design and assessment.

In their most part, architectural projects are also urban design interventions, providing a significant public contribution due to the interface with public streets. This elevates the role and responsibility of *periti* in delivering high-quality designs. In the words of the Architects' Council of Europe (ACE and Zammit 2014¹, p5), the architectural profession needs:

[...] to be more aware of [its] responsibilities in terms of providing better urban environments. And better urban environments start from better streets. And better streets start from better homes. Well-designed places are designed around people.

Quality design is defined as – **contextual** design that follows on from existing design cues but subsequently seeks to provide a contemporary and positive contribution to such cues, **robust** design that may be adaptable to changing needs with least disruption, **energy-conscious** design that seeks to reduce excessive heat gains and heat losses in summer and winter respectively, conserve and actively generate energy and re-use available resources through systems that are designed inherent with the building fabric.

1 Architects Council of Europe (ACE) and Zammit, A. (2014). The role of the architectural profession in delivering responsible design // Le rôle de la profession d'architecte pour une conception responsable. Bruxelles : ACE.

The document places a particular emphasis on enriching the character of the existing context, more specifically the immediate streetscape, not by producing more of the same but by generating creative design responses that build on, and also seek to interpret, existing street qualities. These design responses range from basic street considerations in relation to urban form, such as street enclosure and building/street proportions to individual architectural elements that contribute to the richness, local distinctiveness and legibility of place.

The document's vision has furthermore been developed from nine objectives set by central government (**Table 1**), in discussion with MEPA and the DC 15 WG and which have undergone a process of public consultation prior to their adoption.

No.	Objective
1	<p><i>The document shall be divided into three parts:</i></p> <ul style="list-style-type: none"> • <i>General policies which give a clear direction. These shall be mandatory.</i> • <i>Guidelines which are meant as an aid to encourage creativity, innovation, and suggest alternative solutions. Emphasis will be on aesthetics and the relationship with the contextual environment.</i> • <i>Technical details which consist of a list of mandatory standards to ensure high quality development.</i>
2	<p><i>Document to conform to all strategic documents and policies published by the Authority.</i></p>
3	<p><i>Document should conform to laws dealing with sanitary, civil and accessibility issues together with other provisions and regulations.</i></p>
4	<p><i>Document to address any existing inconsistencies, ambiguities and repetitions in MEPA policies and regulations and also make good for any omissions.</i></p>
5	<p><i>Current provisions which undermine the quality of our urban environment and quality of life to be eliminated.</i></p>
6	<p><i>To revise the policy and design guidance for the Urban Conservation Area and Scheduled Buildings and to encourage good intervention practice.</i></p>
7	<p><i>Good practice guidelines on energy conservation, the use of renewable energy, and the sustainable use of natural resources to form part of this document.</i></p>
8	<p><i>Final document is to be comprehensive, clear and user friendly. Visual aids – illustrations, photos or sketches to encourage a high level of design and urban planning.</i></p>
9	<p><i>This document should be forward looking and encourage innovative design, materials and emerging technologies.</i></p>

Table 1: Central Government objectives for DC 15

Source: Parliamentary Secretary for Planning and Simplification of Administrative Processes, Office of the Prime Minister

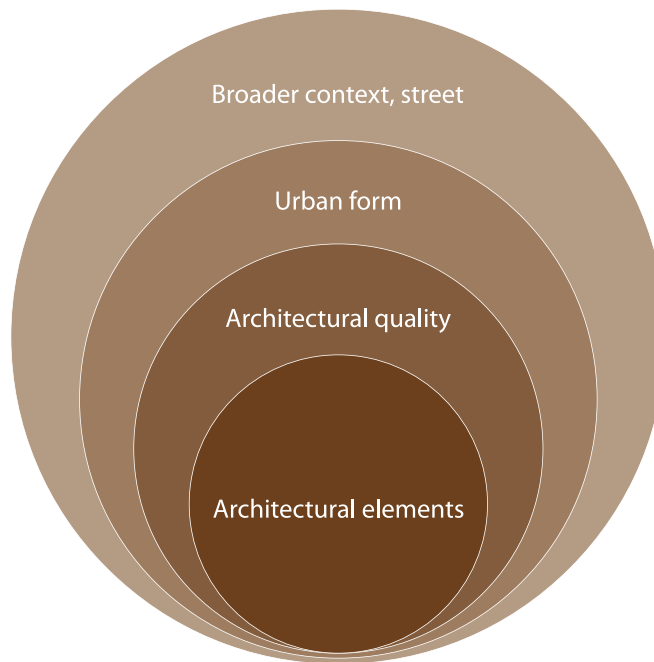

Figure 13: The inter-relationship of spatial scales

1.1.2 An urban design approach

The above sets the scene for the approach that is adopted in DC 15 – an urban design approach that acknowledges the inter-relationship of the different spatial scales (**Figure 13**).

While addressing the entire spatial scale, this approach reduces the emphasis on individual architectural elements and strengthens the attention given to the urban form, being the primary contributor to the formation of the streetscape.

In approaching a design project, the *perit* should be aware of the multifarious role of architectural and urban design in addressing different dimensions of the urban environment, from the physical, tangible qualities to the more abstract, intangible qualities that together allow one to experience the urban environment in its totality.

Design contributes directly to townscape/visual and architectural dimensions of urban environments – key issues include siting, urban grain, massing, frontage proportions (height, width), roofline and skyline, views and vistas (short-, medium- and long-range), architectural façade composition (solid-to-void ratio, openings/fenestration composition, orientation and rhythm), architectural expression and architectural features including materials, details and colour.

Design, however, also has a critical influence in terms of:

- The public realm and the more ‘social’ objectives – issues in relation to accessibility and permeability, open space creation and design (particularly semi-public and semi-private spaces), residential amenity issues (including issues of overshadowing, overlooking, natural surveillance, privacy, security and safety), landscaping design and detailing, parking, inclusion of ancillary elements (such as lighting);
- The sustainable objectives, working closely with the provisions of *Technical Guidance Document F* – in relation to building orientation, reduction of excessive heat gains and losses (summer and winter respectively), maximisation of natural ventilation for summer cooling, aperture orientation, proportion and glazing typology, integration (integrally-designed) energy-saving (such as roof and wall insulation, shading devices)

- and energy-generation measures (such as photovoltaic panels), issues in relation to microclimate (daylight penetration, sunlight and glare implications, prevailing wind and wind-flow considerations); and
- The spatial/perceptual objectives – notably, the distinctiveness of the built form in order to help legibility and orientation, continuity of building lines and frontages that help spatial enclosure and definition, ease of navigation, edge treatment, opportunities to reinforce important visual cues that aid visual orientation within space and different degrees of visual access in accordance with the treatment of spatial interfaces.

1.2 DOCUMENT SCOPE – THREE OBJECTIVES FOR GOOD DESIGN

The document vision translates into three key objectives that double up as the basic framework on which DC 15 has been structured:

- A contextual and street-based approach to design
- Respecting the street as an important spatial scale
- Integrally-designed, energy-conscious, quality architecture

The spirit of each objective is explained next.

1.2.1 A contextual and street-based approach to design

Context should constitute the starting point of any architectural and urban design intervention, from which predominant parameters should be defined.

Any design should seek to **respect and relate** to its context. Here, it will be necessary to explain what this statement means; an even better option would be to state what it is *not* (Figure 14):

- Respecting context does *not* mean that design should copy blindly existing design elements within a defined context. Nor does it imply reproducing architectural elements, particularly if these are taken out of their original context. Different contexts, characterised by different degrees of sensitivity, should be addressed in different manners.
- Respecting context does *not* mean standardising design into modular, template forms that are devoid of personality and individual interpretation. Nor does it mean stifling design creativity or precluding the possibility of innovative design solutions.



Figure 14: Respecting the context – what it does *not* mean

Rather, what the statement **does** mean is:

The definition of broad parameters and qualities, which arise out of a streetscape analysis and that provide the basic framework for the initial design concept, which is then individually enriched and adapted to other aspects in relation to the design brief.

Different parameters would be applicable given the specific nature of different contexts. Such parameters could include, but are not limited to – façade proportion, aperture/ fenestration composition and rhythm, height variations, solid-to-void ratios, interfaces between private and public spaces, material and colour palette variations.

In relation to the above, design should aspire to **enrich and improve** an existing context, by providing contemporary, innovative, rich solutions that follow on such basic parameters and subsequently seek to reinforce certain predominant streetscape and townscape qualities through creative design elements. It might also mean, however, that weak, non-descript contexts might need more radical design interventions that depart entirely from established, negative streetscape qualities and inject a new life into the street with the design of new architectural elements.

A critical consideration with regard to context, particularly considering the configuration of the Maltese landscape, is topography. Many of our urban settlements are characterised by level changes, often very sharp. Respecting context also implies having a close regard to changes in level. The design proposal should fit within the existing topography, such that important visual lines are maintained, the natural landscape is followed and the skyline is adhered to, particularly with regard to maintaining existing visual cues provided by landmarks. This also applies to buildings that are located along sloping streets or lying between streets characterised by sharp level changes – a situation that is commonplace and that is envisaged to increase as more opportunities for comprehensive re/development of multiple buildings/sites occur.

Contextual considerations become even more paramount in Urban Conservation Areas (UCAs), wherein there are pressures for demolition and extensive alterations to properties within the urban fabric of local traditional settlements. As highlighted in Section 1.3.2, this document consolidates the 1995 document *Development Control within Urban Conservation Areas* and a number of provisions in DC 15 deal with UCAs in order to promote urban conservation among property owners, and to give guidance to *periti* and developers in the formulation of development proposals affecting property within UCAs.

The control and management of pressures for change within UCAs should aim to provide the right balance between a static system of restraints, that ensures the conservation of the inner urban fabric, and a dynamic system of stimuli that encourages sensitive and compatible urban renewal in line with the needs of modern society. The main goal of any urban conservation strategy should be to ensure that the evolution of traditional settlements is compatible with the maintenance of the historical continuum. Evolutionary changes such as the reuse and adaptation of historical buildings, the provision of social and community facilities, and the betterment of centuries-old traditional festivals, are not only desirable but also necessary to sustain liveability within the village and town context. As long as change is generated from within and is compatible with the historical continuum, then the evolutionary process is a healthy and progressive one. If the historical context is however perceived as being unduly restrictive, the concept of change may develop regressively and with negative implications. This may result in traditional craftsmanship skills, building materials and building forms being dispensed with, to the detriment of the historic environment.

DC 15 thus provides guidelines for *periti*, developers and others on the renewal of UCAs to ensure that evolutionary changes occurring within such areas are respectful of, and

enrich, their historical context. These guidelines will be used by the Authority in assessing applications within UCAs, so as to encourage a coherent approach towards the control of development within them.

1.2.2 Respecting the street as an important spatial scale – creating successful streets

Every design project must be seen within the totality of its immediate context, which in the majority of cases constitutes the street. Streets are not only transitional spaces – they are important social places and their success is in turn vital to the success of the overall workings of an urban settlement. Designing with the street in mind implies an acknowledgement that every architectural façade is not only an architectural project in isolation – it is also an urban design intervention with a public interface (**Figure 15**).

Creating successful streets therefore also means giving due regard to this interface, in terms of the degree of active frontages that may be created, the relationship of urban form with the human scale, the treatment of semi-public and semi-private spaces such as front gardens, as well as the avoidance of basements along the street frontage.

While broad considerations of urban form define the street, architectural elements further help to enrich it. Building on this leading maxim, successful streets are therefore those that allow for diverse, creative architectural responses to occur within well-defined, harmonised and complementing urban forms. DC 15 is based on this principle.

In order to facilitate, and ensure, that due regard is given to the considerations discussed in sections 1.2.1 and 1.2.2 above, additional submission requirements are being identified as explained in section 1.4.

1.2.3 Integrally-designed, energy-conscious, quality architecture

Architecturally, DC 15 encourages the production of quality designs that provide a valid contribution to their immediate and broader contexts, at the levels of the street, neighbourhood and the wider urban settlement. The design process should follow an integrated approach wherein different elements are designed holistically, starting from the contextual cues that define the design concept, coupled with an energy-conscious, detail-oriented approach that strives to produce high-quality, energy-efficient buildings that furthermore give value to, and enrich, the context within which they are located.

An energy-conscious design reduces the need to heat and cool (with corresponding energy requirements) by ensuring a tight building fabric designed to the highest standards, accompanied by integrally-designed energy conservation and energy generation interventions that allow for the production of green clean energy renewables contributing to the EU's 2020 'nearly-zero energy building' target.

1.2.4 Translating the three objectives within the document

The document's vision and objectives discussed above underpin the document's structure as follows:

- a) A contextual and street-based approach to design is addressed within **Part 2 (Contextual design)**
- b) Respecting the street as an important spatial scale is addressed within **Part 3 (Urban form)**
- c) Integrally-designed, energy-conscious, quality architecture is addressed within **Part 4 (Architectural quality)** and **Part 5 (Architectural elements)**

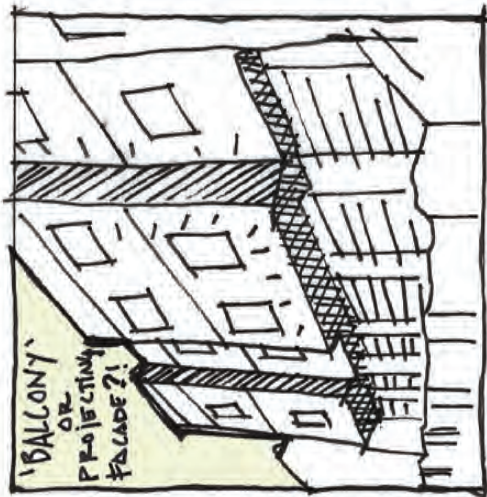
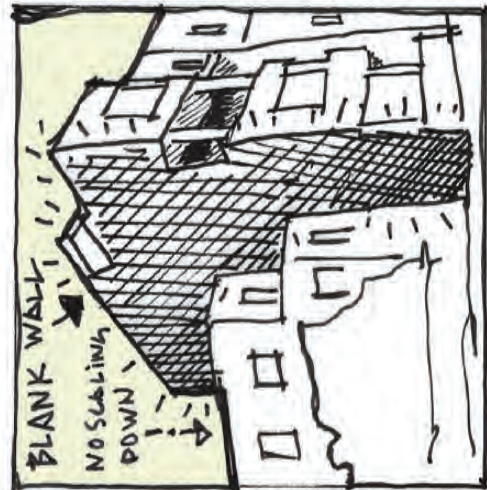

INSTEAD, RELATE TO CONTEXT...

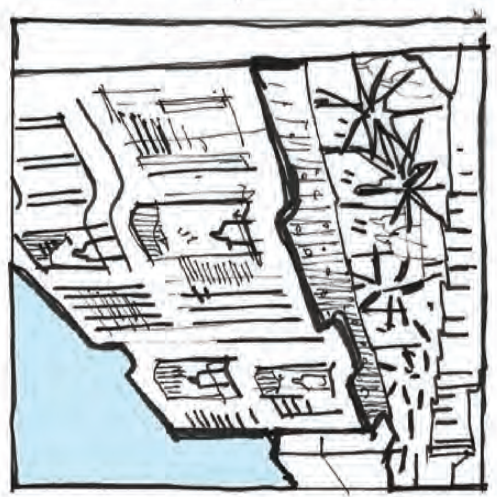
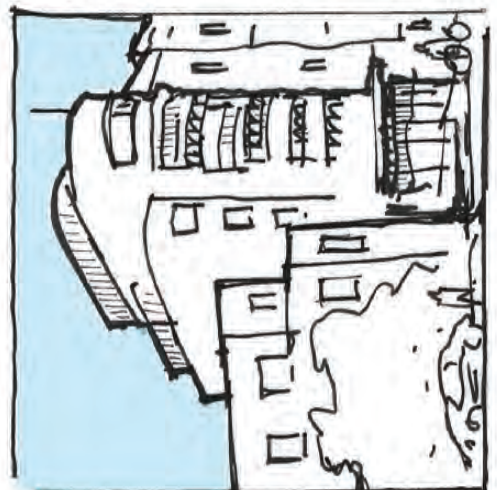
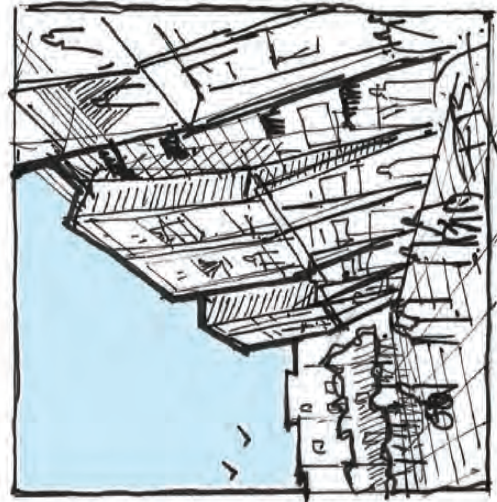

COMPARABLE BUILT VOLUME, YET WITH ARCHITECTURAL INTENT.
— AND, IMPROVED ENVIRONMENT!

Figure 15: Creating successful streets

1.3 DC 15

1.3.1 How to use DC 15

As discussed in the previous sections, the document moves progressively from the broader contextual considerations to focus on issues of urban form, leading to issues in relation to architectural quality and finally zooming into more specific architectural elements.

This logic is based on the recognition that all the considerations discussed in the document contribute to the creation of a quality urban environment but it is equally based on the understanding that some aspects are more critical than others and therefore need a more forceful stand.

In turn, this is reflected in the type of approach the document adopts – distinguishing among:

- **Policy/regulation (P)** which is to have the most onerous weight out of all the document's provisions in the assessment of development proposals and where every effort is focused on objective criteria, not subjective ones;
- **Good-practice guidance (G)** that generally provides the intent and establishes the principle but that may then have diverse solutions to achieve such principle particularly given the subjectivity of some of these provisions; and
- **Technical standards (S)**, which supplement the above in terms of specific quantitative targets and which are non-controversial, objective, universally-agreed numerical considerations.

The following symbols and colours denote the three types of provisions within the document (**Figure 16**).



Figure 16: (from left) Policy/regulation, Good-practice guidance and Technical standards

In line with the new legal framework, the Authority is obliged in its decisions to take into account other material considerations. Such material considerations may result in solutions that are different than those deriving from the strict interpretation of policy.

The policy, guidance and standards are present to different degrees in the individual parts of DC 15, as explained and illustrated below (**Figure 17**).

Parts 2 and 3 of the document, dealing respectively with **contextual design** and **urban form**, are mainly characterised by policies in the acknowledgement that these parts contain critical aspects that have most bearing on the context/street and that can make or break a streetscape – they are the ‘main shapers of the street’. These are therefore the parts that need to be controlled most, not to produce standardised buildings but so as to guarantee certain fundamental street principles and parameters.

Part 4 of the document, dealing with **architectural quality**, contains a mix of provisions, with a reduced number of policies compared to Parts 2 and 3 and conversely a predominance of good-practice guidance.

Part 5 of the document, dealing with **architectural elements**, is in turn primarily characterised by good-practice guidance that could have different architectural solutions and does not contain any technical standards. A greater element of deviation is therefore possible within this section, particularly given the inevitable subjective nature of many considerations contained therein.

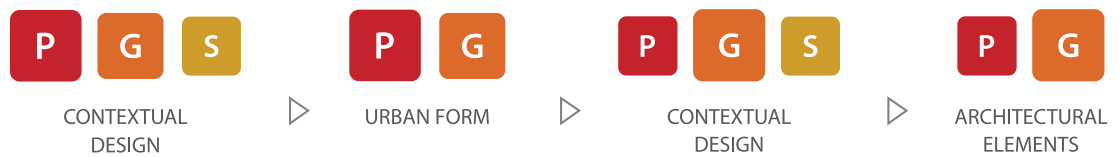

Figure 17: The proportion of Policy/regulation, Good-practice guidance and Technical standards within Parts 2, 3, 4 and 5 of DC 15

The injection of more guidance than policy in Parts 4 and 5, and even more so in the latter part, is done in the recognition that it is primarily through aspects of architectural quality and individual elements that architectural individuality, creativity and innovation may be achieved, allowing for architectural diversity within a consistent streetscape in terms of composition and cohesive quality. Indeed, through this approach, while the fundamental elements that make the building block and street are fixed, the overall outcome is *not* prescribed through a freer hand in architectural development and elemental design.

Further distinction among the three types of document provisions is made in terms of their language – policies and technical standards are unequivocally expressed using terms such as ‘will/shall’, ‘will/shall not’; in contrast, good-practice guidance will be expressed in terms of ‘would/should’, ‘would/should not’. Such language may provide more clarity to the document in terms of those aspects that are fixed and non-negotiable (policies and technical standards), as opposed to those considerations that could be modified and negotiable, and for which more than one solution could be acceptable.

The above new approach differs significantly from DC 07, which was largely characterised by policies that contained a (qualitative) policy description that was seldom taken on board within the (often quantitative) provisions of the policy *per se*. The policies in DC 15 are not simply quantitative in nature – indeed, a policy’s qualitative spirit (previously expressed within the policy description) is being given as much importance as the quantitative component, in order to ensure that both quantitative and qualitative objectives are given equal weight in design, assessment and decision-making.

In addition, through this rethought approach, it is envisaged that the DC 07 ‘urban design concepts’ and objectives for ‘visual architectural gain’ may be better achieved. The relaxation of a number of provisions in connection with Architectural quality and Architectural elements is intended to give the *periti* more freedom in design, which in turn may be considered more openly by planning officers and decision-makers.

A *Quality Checklist* for *periti*, assessors and decision-makers, broadly modelled on the latest UK design guidance in terms of Design Quality Indicators but adapted to local specificities, follows each of the four Parts. These are not simply meant as a ‘tick-box’ exercise. Rather, the questions posed therein are important considerations that the Authority will take into account in evaluating proposals. They also provide designers with a summary of the major issues which they should think about when formulating proposals for new development. These issues can, and should, form the basis for a positive dialogue on a development proposal. Pre-submission discussions, particularly during the initial design stages of a project, are important so that the Authority may guide the applicant on the appropriate approach to these issues. In turn, the *periti* and applicant may avail of this opportunity to explain their basic design philosophy and how these issues have been approached.

Furthermore, in order to frame the document's provisions within the particularities of context, seven predominant 'Area Types' have been established, in accordance with broader Local Plan provisions. This will help to identify where the specific provisions will apply and are particularly useful for design considerations in relation to uses that could be located in very different contexts. For instance, the design of commercial outlets will be bound by different considerations if such outlets are located within a Residential Area as opposed to an Entertainment Priority Area. This is explained in **Part 2** of this document.

1.3.2 Consolidation of other supplementary planning guidance, other key documents

The formulation of DC 15 includes the revision and refinement of *Development Control – Design and Policy Guidance 2007* (DC 2007) together with the consolidation of the following supplementary planning guidance:

- *Development Control within Urban Conservation Areas*, adopted by the PA in July 1995
- *Shop fronts*, adopted by the PA in May 1994
- *Traffic Generation, Access and Parking*, Circular to Architects PA 3/93

The above-listed documents are therefore to be considered as repealed through the adoption of DC 15.

Outside of DC 15 there shall be other key documents that must accompany the design and development management process and should therefore be consulted accordingly. These primarily include:

- *Access for All Design Guidelines; Streets for All – A guide for Access for All in Outdoor Areas; and Facilities providing accommodation for the public – all three documents adopted by the National Commission Persons with Disability (NCPD)*
- *Chapter 10 of the Code of Police Laws*, which establishes the sanitary law
- *Design guidelines on fire safety for Buildings in Malta*, published by the Building Industry Consultative Council (BICC)
- *Guidelines on Trees, Shrubs and Plants for Planting & Landscaping in the Maltese Islands*, adopted by the MEPA on 21st February, 2002
- *Kiosks*, adopted by the PA in May 1994
- *Technical Guidance Document F – Conservation of Fuel, Energy and Natural Resources (Minimum Requirements on the Energy Performance of Buildings Regulations, 2006)*, issued by the Building Regulation Office and legislated by the Energy Performance of Buildings Regulations, 2012 (L.N. 376 of 2012)
- Any relevant *Circular to Architects* that may be issued by the Authority from time to time with regard to specific planning issues

1.3.3 A note on the illustrations used within the document

Where possible, the individual policies, good-practice guidance and technical specifications are supplemented by illustrated figures in order to increase the document's clarity and avoid any issues of doubt. Furthermore, the document now includes real-life examples that illustrate different aspects from the implementation of the document's provisions using both local and foreign examples. Some of these examples also illustrate, in practical ways, the manner in which a number of principles that are being promoted within the document may be achieved through innovative, creative responses that are nonetheless sensitive to their context, most notably the streetscape. In this manner DC 15 doubles up as a showcase of good design principles, not solely as a policy document stating what is allowable or otherwise.

It cannot be stressed enough, however, that these examples are not to be taken literally, in the sense that they do not necessarily constitute the only possible solution in response to specific document provisions.

1.4 DEVELOPMENT PLANNING APPLICATION SUBMISSION REQUIREMENTS

The following new submission requirements are being introduced through DC 15 and are discussed in the subsequent sub-sections.

1. A street photographic survey
2. A streetscape analysis
3. A design statement

Circulars to Architects will establish criteria in relation to the applicability of the above requirements, according to whether the development proposal qualifies as a 'fast-track' or more complex development planning application.

In addition to the above three requirements, all front elevations submitted as part of development planning applications are also to include the elevations that are immediately contiguous to the said development, according to **Figure 18 (c)**.

Furthermore, for works on any scheduled property² the Authority will also require specific information, which is to be submitted with the development planning application in the form of a Restoration Method Statement. Terms of Reference for such Method Statement are available on the Authority's website.

The new submission requirements are not being introduced to make the development management process more onerous on the applicant and *perit*. Rather, this is being done so as to shift the onus of urban and architectural design quality onto these key stakeholders. Specifically, the aims and objectives of the new submission requirements are:

1. To enable architects to explain their design concept.
2. To facilitate the Planning Directorate's understanding of the development planning application, in terms of what has been taken into account from the surrounding context and frame the development proposal within the broader contextual considerations.
3. To establish fixed parameters which are clearly agreed upon by all parties involved, while also possibly identifying those aspects that have not been adhered to especially in terms of policies.
4. To allow architects to explain any deviations from the document's provisions and justify these in terms of the design concept, which will enable both the PD and decision-makers to be able to give weight to their acceptance of the deviations and thus enable the exercise of discretion in allowance with the new Planning Act.

Needless to say, this does not imply that any deviation is permissible. It has already been identified that the way the document is structured enables one to distinguish between a policy, recommended guidance, or technical standard, each of which plays a different role in the development management process and also carries a distinct weight with regard to its adherence, or deviation therefrom.

² Information regarding scheduled properties as available in the Malta Scheduled Property Register is accessible through the Authority's website.

1.4.1 The street photographic survey

Development planning applications are to be accompanied by a street photographic survey, in accordance with **Figure 18 (a)**.

The panoramic photographs are to clearly illustrate both sides of the street that constitute the perimeter block wherein the proposed development is located.

1.4.2 The streetscape analysis

The scope of the streetscape analysis is to study the existing street context that is present around a proposed development, helping one to, first, identify any strong features that are present within the street and, second, draw on such specific elements as a basis for further design development, not in terms of slavishly copying such elements but in terms of their interpretation in a critical and contemporary manner.

The extent of detail to be analysed through the streetscape analysis will necessarily vary according to the scale of the project and sensitivity of context, but would typically include most or all of the following studies on elevation and plan:

1. A **street** assessment, in terms of:
 - a) Street proportion/width
 - b) Natural features, topography and levels (including street levels)

2. A **building** assessment, in terms of:
 - a) Site coverage/layout
 - b) Block form/size/height, including height to width ratio, ground floor height
 - c) Building age, type, style
 - d) Façade proportion/scale/rhythm, façade setback(s)/projections, solid to void ratio
 - e) Apertures (dimension/proportion/position/orientation/materials)
 - f) Predominant vertical/horizontal accent elements/details, materials and colours

In the case of ridges, an assessment of the *back* elevations of the buildings will also be required.

3. A **landscape** assessment, in terms of:
 - a) Fences, boundary walls
 - b) Existing landscape elements, predominant trees/shrubs species

The Area of Influence to be considered for the streetscape analysis is to follow **Figure 18 (b)**.

1.4.3 The design statement

The design statement is a concise but comprehensive write-up developed by the project *perit*, supplemented by visual aids such as existing photos, explanatory diagrams and/or sketches, proposed visuals and photomontages. It departs from the streetscape analysis and clearly provides the design rationale in relation to the proposed development in question.

The design statement will typically include the following sections:

1. A short description project brief/programme.
2. A summary of the main aspects arising out of the streetscape analysis.

3. A justified response to streetscape analysis – a discussion on how to make best use of specific physical features or characteristics present within the context, as well as where and why departure from such features/characteristics has occurred.
4. The key design reference points.
5. A detailed proposal description, including the discussion of any deviation from existing policies and justification thereof.

1.4.4 Areas of Influence for street photographic survey, streetscape analysis, façade submission

This section identifies the Areas of Influence that are to be considered for the street photographic survey, streetscape analysis and façade submission. This will accordingly establish the Areas of Influence that will be taken into consideration during the development planning application's review by the Planning Directorate (**Figure 18**).

The Area of Influence for the street photographic survey (**Figure 18 (a)**) will be the same Area of Influence taken for the analysis of building heights, as discussed in **Policy P33**.

The Area of Influence for the streetscape analysis (**Figure 18 (b)**) and façade submission (**Figure 18 (c)**) will depend on the location of the proposed development with regard to the rest of the street context, in terms of whether it is a corner site/building, near-corner site/building and mid-block/infill site/building.

The key messages from **Part 1** are schematically illustrated within **Figure 19**.

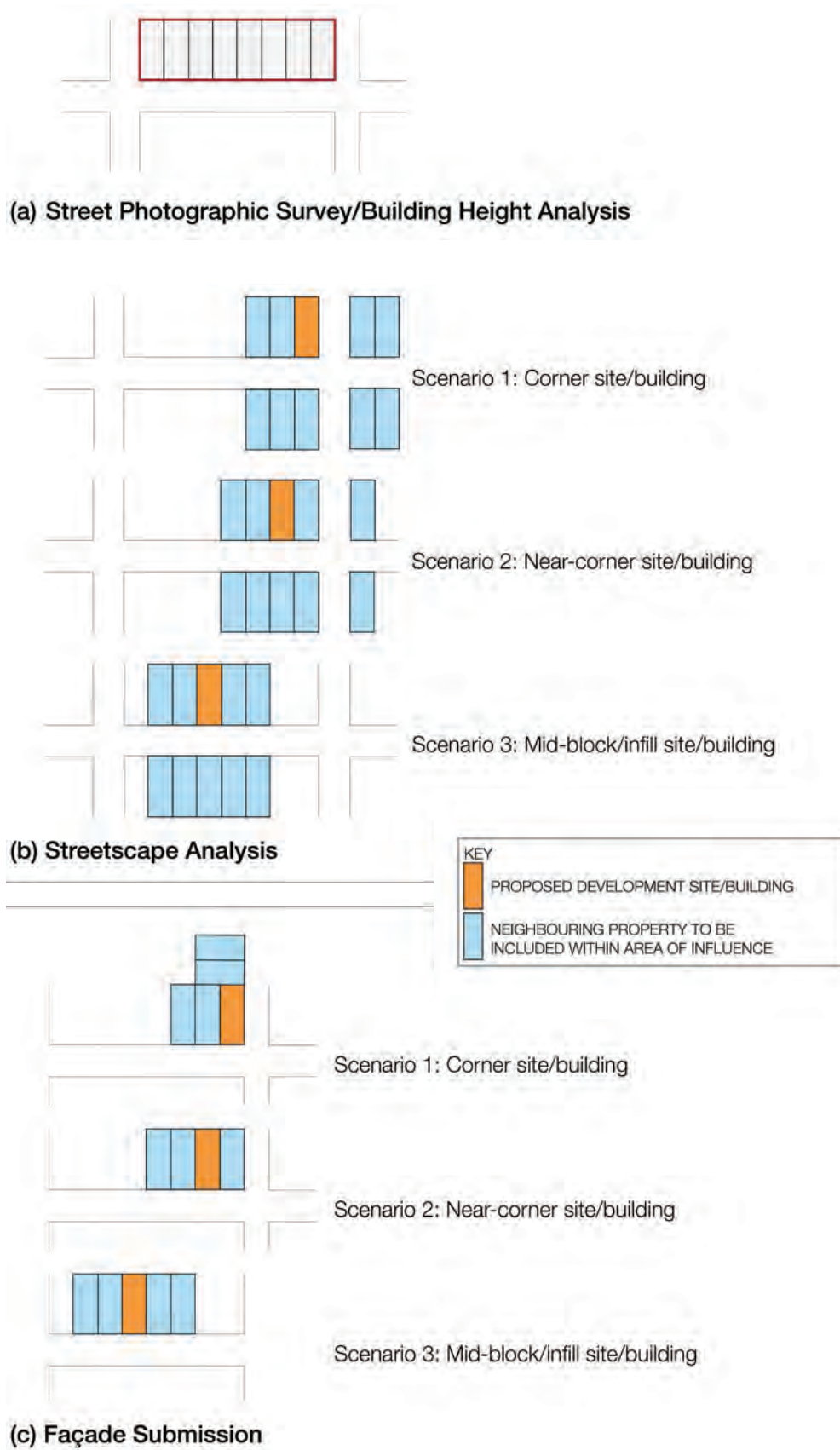

Figure 18: Areas of Influence for street photographic survey / building height analysis, streetscape analysis, façade submission

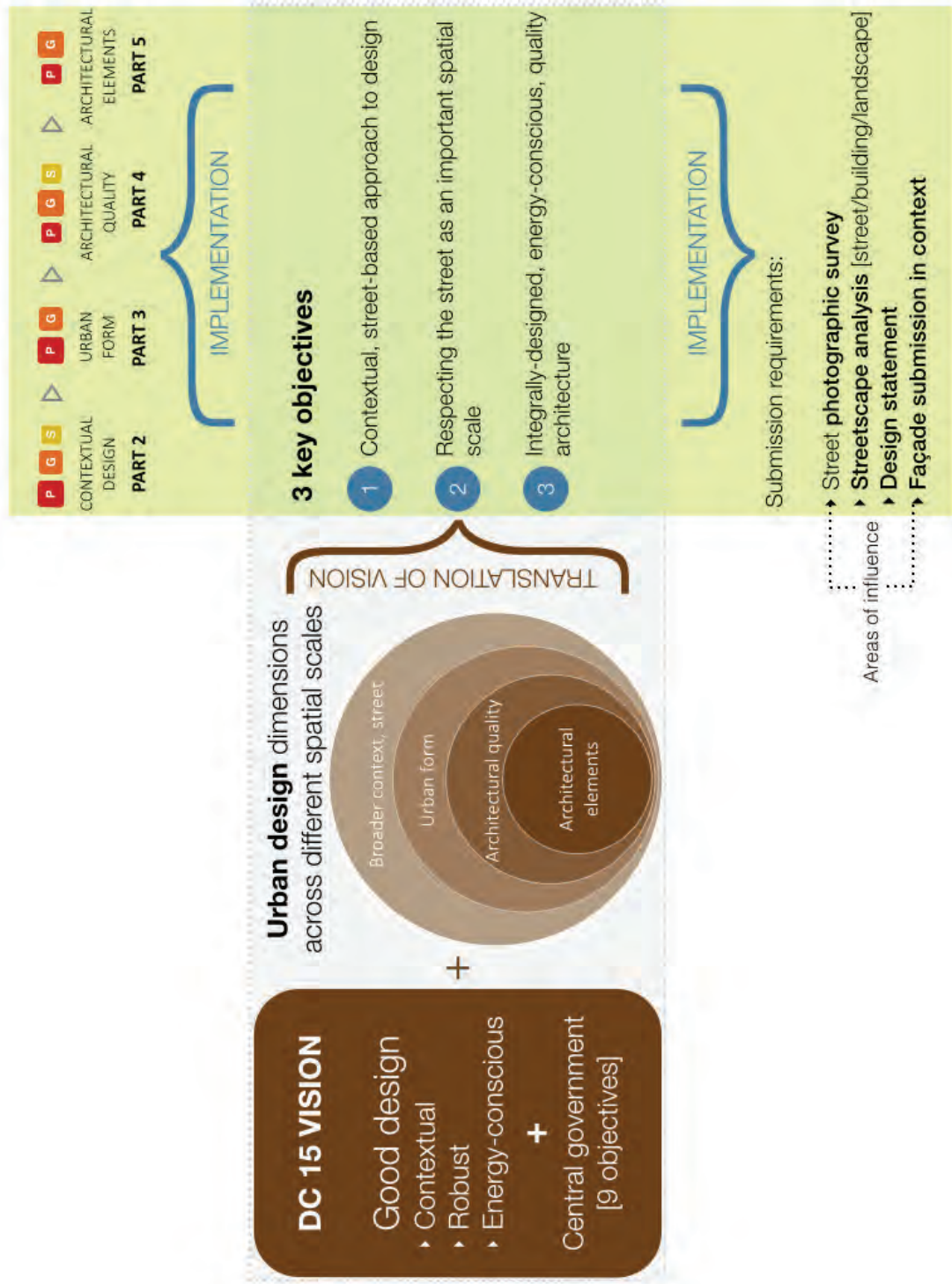

Figure 19: Part 1 – Key messages



02

CONTEXTUAL DESIGN

- 2.1** LOCAL DISTINCTIVENESS
- 2.2** NATURAL FEATURES
- 2.3** BUILT FEATURES – STREETScape CHARACTER
- 2.4** BUILT FEATURES – FRONT, SIDE AND REAR GARDEN
BOUNDARY WALLS
- 2.5** DEGREE OF ACTIVITY – ACCESSIBILITY AND MOVEMENT
- 2.6** DEGREE OF ACTIVITY – PARKING AREAS AND GARAGES/
VEHICULAR ACCESSES
- 2.7** CONTEXTUAL DESIGN – QUALITY CHECKLIST FOR PERITI,
ASSESSORS AND DECISION-MAKERS

The general intent of **Part 2** is to acknowledge the unique identity of the Maltese territory. In this spirit, **Part 2** deals with important contextual parameters that contribute to the local distinctiveness of a setting – in terms of natural features, built features and the degree of activity. In this manner, *periti*, assessors and decision-makers are enabled to think about the predominant contextual considerations that are to be taken on board during the design process and its assessment. Variations with regard to these parameters result in the identification of distinct Area Typologies, wherein different provisions from DC 15 will apply (section 2.1).

The document then zooms into the three components of setting – **natural features** (section 2.2); **built features**, in relation to a streetscape’s definition and character, focusing on the relationship between street and buildings (in terms of height to width ratios), the relationship between new and existing buildings and the need for transition design solutions (section 2.3); built features, in relation to front, side and rear gardens (section 2.4); and issues in relation to the **degree of activity** – accessibility and movement (section 2.5) and parking areas and garages/vehicular accesses (section 2.6) (**Figure 20**).

Vehicular accesses, parking, loading/unloading operations and bays have significant contextual implications. In particular, the form and function of parking can have a determining influence on the success and viability of the overall development and increase the amenity of the surrounding context.

For this reason, Sections 2.5 and 2.6 are intended to promote a consistent best practice in terms of accessibility, movement and parking, laying out, amongst others, internationally accepted geometric standards which seek to obtain the safe and convenient use of vehicular accesses, parking areas and/or ramps. The overarching principles of the provisions in these two sections are to have safe and convenient vehicular parking spaces and accesses, to protect all road users (motorists and vulnerable road users such as pedestrians) and to minimise conflicts, hence safeguarding road safety and road capacity. The majority of these provisions are therefore technical standards based on objective geometric considerations, the departure from which may have serious repercussions on the use of the space in question, for which it is intended.

2.1 LOCAL DISTINCTIVENESS

2.1.1 Identification of *Area Typologies*

Five *Area Typologies* have been identified (**Figure 21**) in order to facilitate the application of different provisions present in this document to different existing contexts rather than applying a generic ‘one-size-fits-all’ approach that would otherwise occur irrespective of context.

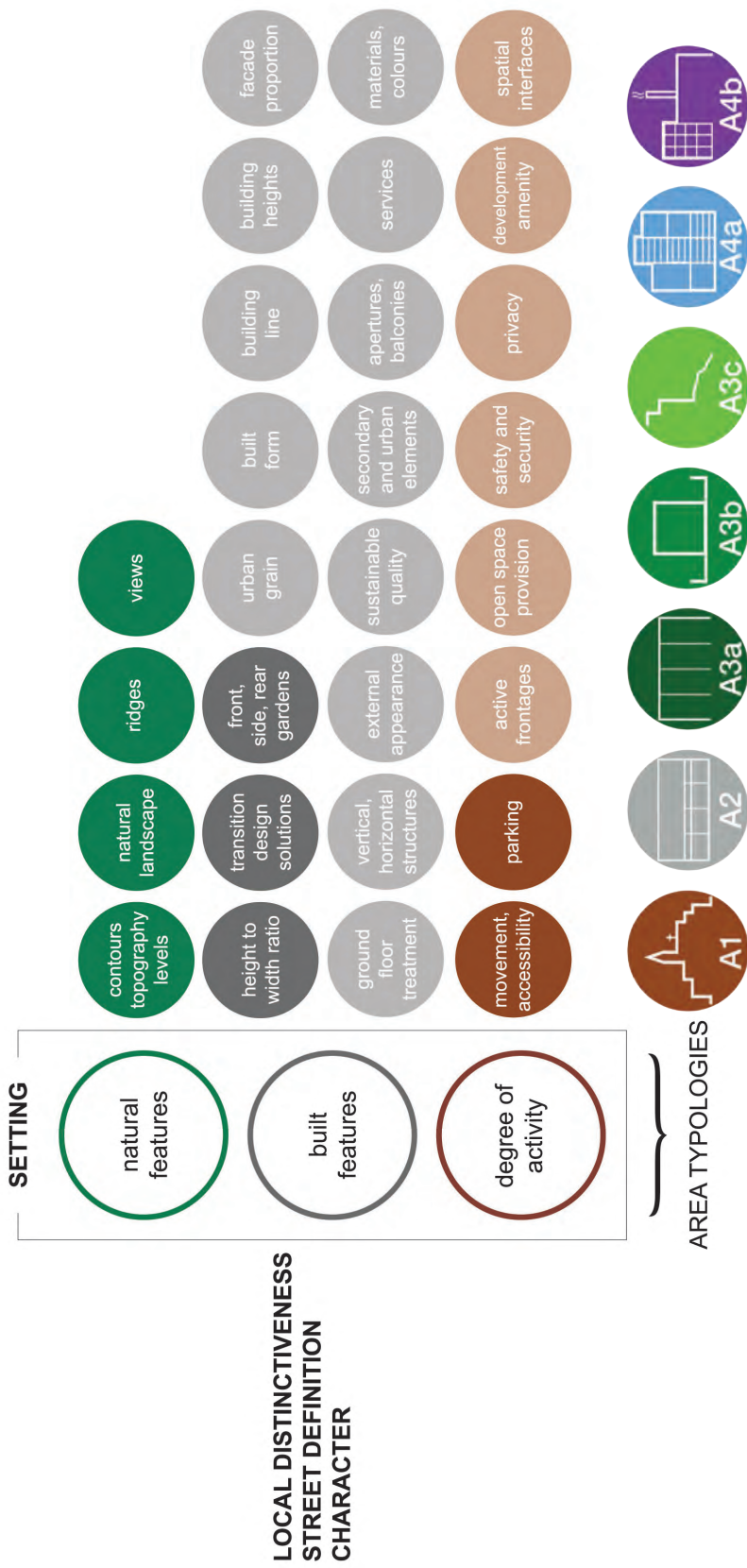
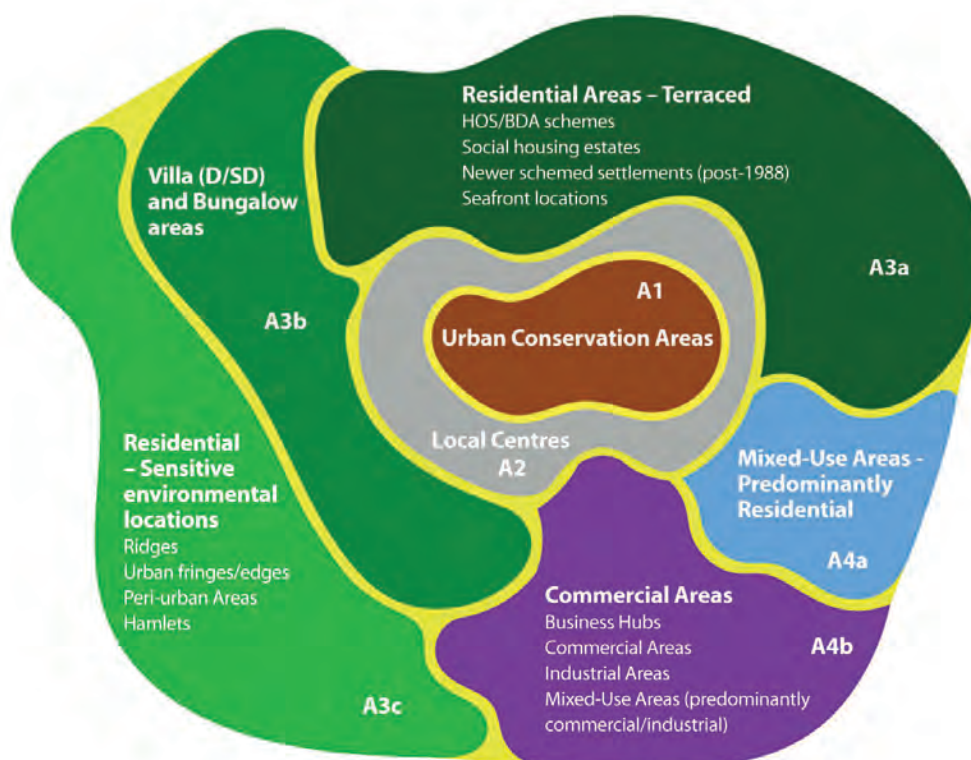

Figure 20: Contributors to setting, local distinctiveness and streetscape – the remit of Part 2 is highlighted

These Area Typologies are meant to enable *periti* and assessors to: apply specific provisions to particular contexts in an easily identifiable manner; and commence the design and assessment process respectively by questioning in the first instance where the development is located.



Note: The yellow fill denotes potential Transition Zones/Areas

Figure 21: Area Typologies dealt with within DC 15

The individual Area Typologies, denoted by colour-coded symbols (**Figure 22**), include:

A1 – for development located within **Urban Conservation Areas**

A2 – for development located within **Local Centres**, or any corresponding designation within the Local Plans that may replace this typology.

A3 – for **Residential areas**, both within designated Residential Areas and Residential Priority Areas, with an inherent distinction as to whether such development is:

- **Terraced** (A3a), including seafront developments (any block having at least one frontage facing the sea),
- **Fully or semi-detached villas/bungalows** (A3b), or
- Located in **sensitive environmental locations**, notably edges and ridges (A3c).

A4a – for **Mixed-Use Areas** that are **predominantly residential**.

A4b – for **Commercial areas**, including development found within **Business Hubs, Commercial Areas, Industrial Areas** and **Mixed-Use Areas** that are **predominantly commercial/industrial**.

In the interim period until the approval of the Local Plans this Area Typology will be applicable in Primary, Secondary and Tertiary Town Centres, Entertainment Priority Areas, Tourism Areas, Resort Zones, Commercial Areas and Industrial Areas.



Figure 22: Area Typologies denoted within DC 15

Each provision within DC 15 also includes reference to the specific Area Typologies that are applicable.

This is particularly relevant in the case of non-residential uses (for instance, a shop front), which will normally have specific design considerations applicable in non-residential enclaves or zones (such as commercial or industrial enclaves, Entertainment Priority Areas, Tourism Areas/Zones and Resort Zones). If such non-residential uses are however present in a UCA, Local Centre or Residential Area, the provisions that are applicable to these Areas will apply and take precedence over any possible conflicting consideration.

In general, if an area falls within more than one Area Typology, the provisions related to the more onerous Area Typology are to prevail. Specifically, if the area is also designated as A1 (Urban Conservation Area) these considerations will prevail over those related to other Area Typologies.

2.1.2 Contribution to the urban landscape

G1

CONTRIBUTION TO THE URBAN LANDSCAPE



Any development should aim to create urban environments with local distinctiveness, in the sense of both a distinctive Maltese identity and a character reflecting that of the specific place in which it is to be located. It should seek to respect and enrich its context, in terms of the:

- a) *natural features – with regard to the natural landscape per se to issues in relation to topography, contours and site levels;*
- b) *built features – including issues with regard to the particular urban form, architectural quality and architectural elements of its settlements; and*
- c) *degree of activity*

of the particular area in which it is situated.

G2

VISUAL IMPACT OF DEVELOPMENT



Roofscapes are not only seen at street level but have long-distance implications. They should therefore be carefully studied and assessed, particularly due to topographical changes (in line with the discussion in Policy P2) and the existing townscape's configuration. The impact of development on the skyline should therefore be taken into consideration.

P1

EXTENT OF COMMITMENT



The extent of commitments that is to be taken into account when analysing an existing context will include:

1. existing legal developments that are physically present on site;
2. valid planning commitments even if such commitments are as yet unbuilt; and
3. any future commitments provided for by the Local Plans, even if the commitments are as yet unbuilt.

2.2 NATURAL FEATURES

A main determinant of the natural landscape is topography, defined by changes in level and a degree of sensitivity in visual terms with regard to important sightlines and visual cues. Numerous Maltese settlements are characterised by topographical variations, some of which may be quite significant. Respecting topography implies the need for some form of control, which inevitably demands a quantitative component to ensure that height limitations established in the Local Plans for the areas in question are never exceeded (Figure 23).



Figure 23: Landscape and topographical variations

P2

TOPOGRAPHICAL
CONSIDERATIONS

It is very possible to have a building that is to be designed within a site that (a) lies at the edge of a development zone where the topography is sloping; (b) lies on a sloping street frontage; or (c) has frontages on two streets located at different site levels. The two streets might furthermore be characterised by different height limitations.

In either of these cases it will be critical for the design proposal to fit as seamlessly as possible within the particular topography, reflecting the profile and basic contours/levels that characterise the particular site, rather than trying to compete with them and resulting in a significant visual impact. For this reason, a design proposal in this context must fulfil the following four requirements:

- a) Its profile must be stepped in accordance with the site topography.*
- b) The height limitation in either the higher or lower street must not be exceeded.*
- c) It must not generate any blank party or rear walls.*
- d) It must not result in a design that causes privacy issues (through the possibility of overlooking) and environmental issues (issues in relation to light and ventilation), without prejudice to third party civil rights.*

In such circumstances together with the development planning application it will be required to submit:

- a) Official and accurate cross-sections through the site and adjacent streets showing existing street levels and site levels prior to any site clearance or other work; and*
- b) A site survey with spot levels.*

The street levels will be checked by the Authority's Land Survey Unit in order to ascertain precise site levels and avoid any doubt as to these levels and the topography of the site relative to the proposed development.

Ridges provide an even more sensitive context, wherein a design scheme has significant implications in terms of long-distance views (**Figure 24**).



Figure 24: Development massing along a ridge edge

P3**DEVELOPMENT
ON RIDGES**

With regard to developments on ridges, the following specific parameters must be respected:

- *A distance must be kept from the ridge edge so as not to impinge on the sensitivity of the area and to allow for adequate excavation to occur if physically possible.*
- *In terms of urban form, the primary focus will be on the visual interest that may be created through a massing scheme that generates interesting, cubic proportions that give rise to plays of light and shadow, and that respect the sensitivity of the landscape. For this reason, long and monolithic façades will not be acceptable. It will also not be acceptable to generate large expanses of blank rear and party walls.*
- *In terms of design treatment, the massing of the design scheme must be accompanied by well-balanced solid: void ratios.*

2.3 BUILT FEATURES – STREETScape CHARACTER

The discussion held in Part 1 (Section 1.2.2) identifies a number of opportunities to design good streets by providing a positive street definition and enriching the street character. The specific contributing elements are illustrated in **Figure 20** above, and in the first instance require the definition of the relationship of urban form with the human scale (which is further elaborated upon in Part 3), the relationship between new and existing buildings (including the possibility of transition design solutions) and the treatment of semi-public and semi-private spaces (specifically, the design and treatment of front, side and rear gardens).

2.3.1 Applying height to width ratio in Urban Conservation Areas**P4****APPLYING HEIGHT TO WIDTH RATIO IN URBAN
CONSERVATION AREAS**

In the case of Urban Conservation Areas, the existing committed prevailing height to width ratio will be derived through a streetscape analysis, the extent of which (Area of Influence) is illustrated in Figure 18 (b) in line with the provisions in Policy P34.

For the purposes of this policy only, the extent of existing commitments will be defined as:

- *existing legal developments that are physically present on site; and*
- *valid planning commitments even if such commitments are as yet unbuilt.*

2.3.2 Relationship between new and existing buildings, transition design solutions

Much development takes place by the redevelopment of previously developed sites within existing urban areas. New development should be compatible with the existing urban fabric (**Figure 25**).



Figure 25: Contemporary development within an existing urban area

G3**RELATIONSHIP BETWEEN
NEW AND EXISTING BUILDINGS**

As and where appropriate, dominant defining design considerations of adjacent buildings should be identified and reinterpreted into the new development. Such design considerations will vary from parameters with regard to urban form, where there should be a concerted effort to relate to such issues, to more specific issues in relation to architectural quality and architectural elements, which may or may not be reinterpreted or possibly reproduced, depending on the specificities and sensitivity of context.

Where a uniform design prevails and it may be established, through a streetscape and photographic analysis, that a number of important streetscape parameters exist that merit inclusion within the proposed development, the emphasis will be on respecting, and possibly as far as practical reproducing, such parameters.

Where a uniform design does not prevail and/or it may be established, through a streetscape and photographic analysis, that the overall street quality is low and inconsistent, the emphasis should be on high-quality contemporary designs that seek to introduce new positive urban design principles into the streetscape.

Transition zones/areas, as defined within the Local Plans, have a distinct character. In these zones/areas, particular attention is to be given to bridging between the adjoining areas, each having their own specific characteristics. Design interventions in terms of urban form and architectural quality will be gradually and incrementally introduced in order to achieve a better transition between developments while safeguarding the qualities of the more sensitive area, in line with the provisions in Policy P6.

P5**PROPOSALS FOR THE
REHABILITATION OR
DEMOLITION OF SCHEDULED PROPERTIES
AND PROPERTIES WITHIN URBAN CONSERVATION AREAS**

Applications involving demolition of scheduled properties and properties within Urban Conservation Areas, will not normally be considered. In considering applications for demolition, regard will be given to:

- a) *the Grading merits provided by policy;*
- b) *the state of repair of the existing building, including dampness, deterioration of stone and structural safety;*
- c) *the internal condition of buildings, in particular sanitation issues, room size, levels of natural lighting, and other internal structural condition;*
- d) *the existing use of the building or its most recent use, if vacant;*
- e) *the broader context of the building, including any important features related to streetscape, adjacent building heights and adjacent uses;*
- f) *any external architectural elements, including garden walls, and architectural features on the façade discussed in Part 5 of this document;*
- g) *any unique internal architectural spaces and features such as mill rooms, alkovi, raffijiet, and stone spiral staircases; external architectural spaces such as internal courtyards and gardens; as well as construction and roofing techniques including, but not limited to, barrel vaults, arches, kileb, xorok tal-qasba and others; and*
- h) *any other significant elements.*

The Authority encourages the rehabilitation and restoration of heritage buildings. When such rehabilitation is to be considered, or the proposal is for developing a gap site, the proposed street elevation would be judged on a case-by-case basis and in relation to any existing buildings and the surrounding environment. For this reason the proposed elevation must be submitted in the context of the existing urban fabric, in line with the provisions of Policy P1. In assessing the new street elevation(s), the Authority may request the re-integration of vernacular and traditional features that were present in the original elevation.

Often, the need for transition design solutions arises due to different allowable height designations or due to the presence of existing, or committed, height variations within different development zones. No specific transition design solutions are being prescribed since these will be very much context-dependent, in terms of whether the different interfaces or developments are: (a) immediately adjacent; (b) opposite one another; (c) back-to-back; or (d) occurring within corner plots.

P6

TRANSITION DESIGN SOLUTIONS



Transition design solutions may be required along the edge of transition zones/areas, at the interfaces between different Local Plan designations such as height and zoning, but also within the same designations where there are existing commitments.

A) Edges of transition zones/areas and interfaces

Such interfaces include the interface between the termination of an Urban Conservation Area (UCA) and the remaining development zone; the interface between some Residential Areas (RA) and villa/bungalow areas; the interface between non-residential enclaves and residential areas; and the interface between edge of the Development Zone (DZ) and Outside Development Zones (ODZ).

Transition solutions immediately outside UCA

Specifically, where development is sited immediately adjacent to an UCA, it will not be higher than the height of the predominant buildings located within the stretch of the perimeter block with frontages in the UCA in question (refer to Figure 18 (a)), so as not to visually dominate the streetscape or other spaces within the UCA. If it adjoins a garden in the UCA, it will be of an appropriate height in relation to the garden wall and set back from that wall by a minimum distance of 3 metres. In this manner the height of the new building will reflect its context and be related to the height of the wall, the size of the garden or space, the distance of the building from that garden, and its overall effect on the garden.

Transition solutions immediately outside villa/bungalow area

Where development adjoins a side garden in villa or bungalow area, it will be of an appropriate height in relation to the side garden wall. In this respect it will be allowed to reach the height limitation of the villa/bungalow area, above which each additional floor shall be set back by a minimum distance of 3 metres.

Transition solutions for non-residential enclaves adjoining residential areas

With regard to non-residential sites that adjoin residential areas, the Authority will:

- i) consider the impact of the non-residential use on the adjoining residential area, and so will not allow those forms of development which are likely to give rise to adverse impacts which cannot be satisfactorily ameliorated; and*

- ii) *require measures to be taken to reduce the impact on adjoining residential areas through the minimisation of openings (doors, windows, etc.) on the boundary(ies) with residential development, and proper noise reduction measures (including insulation, screening of noise sources, reduction of noise at source, appropriate layout etc.) as well as the built-in design of green, or other suitable, buffer zones.*

Transition solutions between DZ edge and ODZ

While the development of existing edge plots located outside the DZ will be acceptable in principle, the Authority will ensure that a suitable transition will be achieved in terms of built volume between the sites within the DZ and the ODZ. The criteria for delineating such edge plots shall be:

- i) *An existing street frontage not exceeding 10 metres.*
 ii) *Located adjacent to an existing blank party wall. The depth of the edge plot will not be allowed to exceed the length of such party wall.*

Within these edge plots:

- a) *A height transition will be sought. The development must be stepped such that the height of development immediately adjacent to the ODZ will not be higher than 8.5 metres measured externally. It will subsequently be stepped until it reaches the height established for the rest of the DZ, with terraces having a minimum depth of 3 metres each. A roof structure having an area and height according to the provisions of Policy P39 will be permitted.*
 b) *The development must have a side curtilage of at least 3 metres on the side of the ODZ. Such open space will be landscaped using indigenous species and be designed in a manner to mitigate the impact of the built fabric. No garage will be allowed within the side curtilage.*
 c) *No blank walls will be generated with the development.*
 d) *A high architectural design quality will be sought given the prominence of the edge plots and their significant visual implications. In particular, attention in assessment will be given to its massing and the degree to which it relates to its surrounding context and its character, both within and beyond the DZ.*

B) Within individual Area Typologies

Such instances include terraced residential development wherein it may be sensible to transition between such existing developments and higher existing or committed developments. Normally such transition will occur on the higher height limitation unless the higher height limitation is already committed, in which case the transition may occur on the lower height limitation.

Specifically, there may be instances where there is an existing side blank wall and where the higher of the two buildings (covered by planning permission) exceeds the height limitation for that street. Three specific scenarios may be envisaged, each demanding a different solution (Figure 26):

- The higher existing building is the only commitment located in a site within the side of the perimeter block fronting the street in question (as delineated in Figure 18 (a)), other than the corner – in such instances, no transition solution will apply (Scenario 1 in Figure 26).*
- The proposed infill development lies between two higher existing commitments located along the stretch of the perimeter block fronting the street in question (as delineated in Figure 18 (a)) – in such instances, a transition solution will apply and will be directed at closing the gap between the two commitments, adhering to the height of the lower of the two commitments (Scenario 2 in Figure 26). This solution will not apply if the*

proposed development lies between a higher infill commitment and a higher corner commitment, and will also not apply if the two higher commitments are located at the extreme corners of the perimeter block.

- The higher existing building is the only commitment located in a corner site within the perimeter block (Scenario 3 in Figure 26) – in such instances, a transition solution will apply if the difference in height is more than one floor. The Authority may allow an additional floor or floors (which may be setback if applicable) over the lower of the two immediately adjacent properties even if this will not conform with the maximum building height limitation for that street, provided that the resulting stepping down effect is to the satisfaction of the Authority and provided further that:
 - i) the resultant development is compatible with its immediate surroundings;
 - ii) the additional floor or floors will result in an improved streetscape;
 - iii) the resultant development will not negatively impact the adjacent area;
 - iv) no new blank party walls are generated by the additional development; and the architectural design of the facade of the additional floor or floors complements the character of the existing building. Due regard will be given to the provisions discussed in Guidance G3.

In establishing the validity of existing commitments, the Authority will give regard to the criteria in Policy P1.

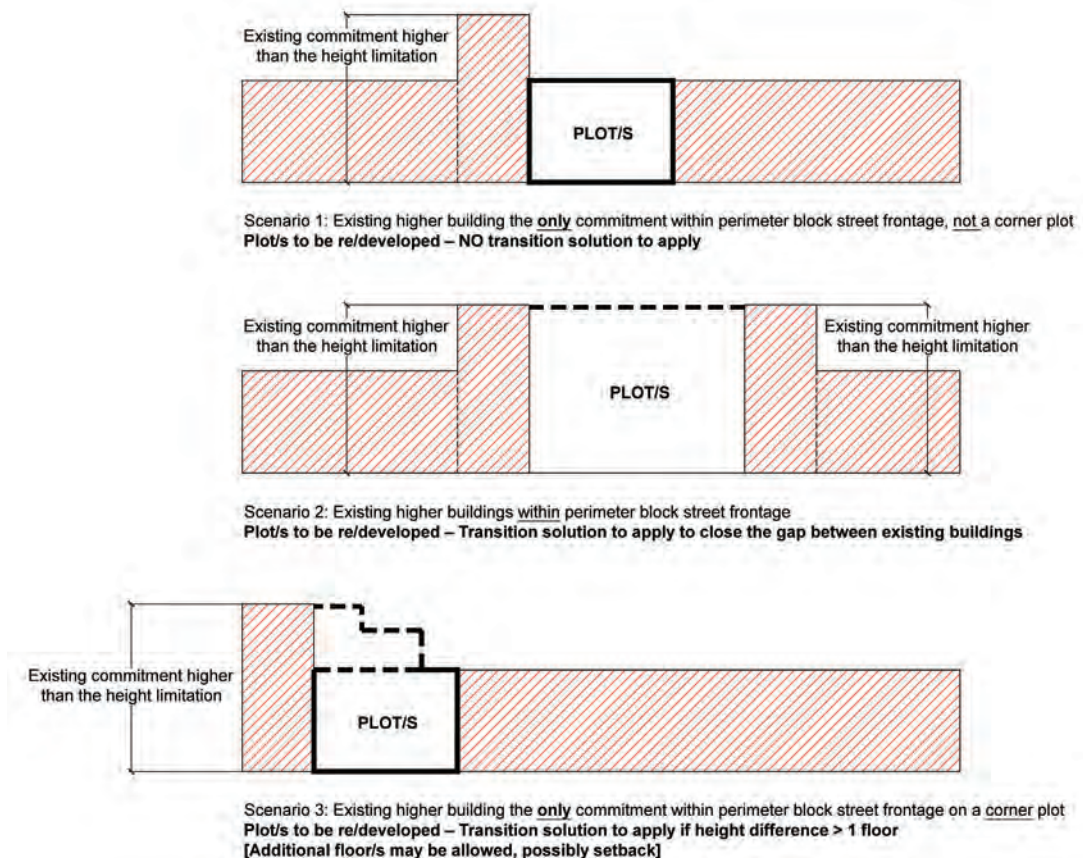

Figure 26: Transition design solutions – 3 scenarios

2.4 BUILT FEATURES – FRONT, SIDE AND REAR GARDEN BOUNDARY WALLS

2.4.1 Front garden boundary walls

Boundary walls serve an important threefold function in the (a) demarcation of property boundaries; (b) spatial enclosure and provision of privacy; and, in the case of front gardens, (c) contribution to the broader street context by means of their public interface and visibility. For this reason front gardens are normally defined as semi-public/semi-private spaces lying at the intersection of the public realm of the street and the private realm of the dwelling and should serve their functions in a manner that does not negatively affect or alter the general character or townscape qualities of a street or neighbourhood. This is ensured through good-practice guidance with regard to its design and the degree of landscaping present within it, as well as through policy with regard to its height (Figure 27).



Figure 27: Well-proportioned front garden boundary walls

G4

DESIGN OF FRONT GARDEN BOUNDARY WALLS



Front garden boundary walls (and the side/party wall within front gardens) should reflect the design and materials of the building of which they form the boundary, and they should be in-keeping with the general character, streetscape and townscape qualities of the wider context. It may be possible to have a boundary wall composed of:

- a) *a green hedge;*
- b) *an open fence or louvered structure that is suitably coloured;*
- c) *a low solid wall, preferably constructed in natural stone or in stone or concrete having a suitably textured, painted or clad finish; or*
- d) *a combination of the above three options, wherein the low solid wall may be topped by a green hedge or a suitably designed open fence structure, the latter preferably constructed in timber or metal.*

Notwithstanding the above, and in line with the provisions in Guidance G3, where it may be established that a streetscape has been developed with a uniform front garden boundary wall design that provides an important contribution to the street's character, such design should be retained for the new front garden boundary walls in that street (Figure 28).



Figure 28: Existing front gardens providing street rhythm

P7

HEIGHT OF FRONT GARDEN BOUNDARY WALLS



The maximum allowable height of front garden boundary walls (and the side/party wall within front gardens) will be dependent on the chosen option identified in Guidance G4, and will be established in order to ensure that the walls do not overly dominate their contexts and do not obstruct visibility with regard to pedestrian and vehicular safety:

- a) *In the case of green hedges, the maximum allowable height will be 1.5 metres above the external finished pavement level.*
- b) *In the case of an open fence or louvered structure, the maximum allowable height will be 2.25 metres above the external finished pavement level.*
- c) *In the case of a low solid wall, the maximum allowable height will be 1.4 metres above the external finished pavement level.*
- d) *In the case of a combination of the above, the maximum allowable height of the bottom solid component will be 1.4 metres above the external finished pavement level, topped by a green hedge, open fence or louvered structure having a maximum allowable height of 0.85 metres, for a total height of 2.25 metres above the external finished pavement level.*

In all cases, the maximum allowable height of any gateposts together with any pillars that may be required for the structural stability of the wall will be 2.25 metres above the external finished pavement level. Such pillars will be adequately spaced.

Where the site is sloping, the front garden boundary wall will be stepped such that the maximum height reached for each step will never exceed 1.8 metres.

In line with the provisions in Guidance G3 and G4, where it may be established that a streetscape has been developed with a uniform front garden boundary wall height, such height will be retained for the new front garden boundary walls in that street.

2.4.2 Side and rear garden/yard boundary walls

P8

SIDE AND REAR GARDEN/YARD BOUNDARY WALLS



The Authority will allow the construction of new, or the extension of existing, side and rear garden/yard walls up to 3.4 metres above ground floor level, except for developments lying on exposed edges or ridges or developments facing ODZ. Applications for walls in excess of this height will only be allowed if:

- a) *the materials to be used are compatible with those used in the dwelling and with the character of the area;*
- b) *the wall would not adversely affect the residential amenity of adjoining properties in terms of the restriction of natural light and ventilation as well as the possibility of over-shadowing that could be caused; and*
- c) *the wall would improve the privacy of any of the adjoining parties.*

In all cases the side wall is to step down towards the front. Within the confines of the front garden itself, the height of the side wall is not to exceed that of the front garden wall, according to the provisions in Policy P7.

2.4.3 Front gardens – landscaping design

Well-designed and landscaped front gardens constitute an important defining element within streetscapes, particularly when characterised by detached and semi-detached dwellings. For this reason, the requirement to landscape front gardens is being reinforced (Figure 29).



Figure 29: The contribution of well-landscaped front gardens

G5

FRONT GARDEN
LANDSCAPING DESIGN



All front gardens, wherever they may be present, should be landscaped although this becomes a more pressing aspect within detached and semi-detached dwellings.

*In the choices related to the landscaping design, due regard should be given to the document **Guidelines on Trees, Shrubs and Plants for Planting & Landscaping in the Maltese Islands (MEPA, 2002)** so as to establish the appropriateness of species used that may contribute to the enhancement of local identity, as well as existing predominant landscape elements present within the streetscape. There should also be a preference for trees over shrubs, given the central contribution of the former elements to a street's character.*

2.4.4 Front gardens used for driveways and carports

Where part of the front garden – the side curtilage – is used to serve as a carport, there should be enough space to ensure that the car does not overhang onto the pedestrian footway.

P9

DRIVEWAYS, FORECOURTS AND CARPORTS



A carport will not be allowed if a garage is permissible within the side curtilage of detached and semi-detached dwellings, as discussed in Policy P22.

Driveways, forecourt of garages located in the side curtilage of detached and semi-detached dwellings or carports will be at least 4.8 metres in depth, measured from the building line. There must be no overhang onto the pedestrian footway, which would otherwise pose a danger or inconvenience to pedestrians who would be forced on to the carriageway. Such carport is to be well designed such that it may contribute positively to the architectural homogeneity of the rest of the dwelling.

Provided that the applicant submits sufficient supporting evidence, this policy may be relaxed to reflect a particular situation or context; nonetheless, no vehicle overhang onto the footway will be allowed.

2.4.5 Front gardens in non-residential developments

The policy seeks to minimise any potential inconvenience to neighbours (both of a residential and non-residential nature located above and to the sides of the development in question) that may arise due to the use of the front garden.

P10

FRONT GARDENS IN NON-RESIDENTIAL DEVELOPMENTS



The use of the front garden of non-residential development will be favourably considered provided that:

- a) *The use of the front garden will be ancillary to, or an extension of, the existing non-residential use on the ground floor and not a separate business unit.*
- b) *The use will be restricted to the display of goods for sale (in the case of retail outlets) or the placing of tables and chairs (in the case of food and drink outlets) only. Use of the front garden area for storage purposes will not be acceptable.*
- c) *The use will not impede access to overlying and/or adjacent residential or non-residential units.*
- d) *The use will not have an adverse impact on the amenity of adjoining residential or non-residential uses in terms of noise, disturbance and/or loss of privacy.*
- e) *The use will not obstruct or encroach on the footway/pavement or carriageway.*

The design of any fixed, demountable structures, canopies or awnings located within these front gardens is to follow the provisions in Policy P50. Furthermore, in the case of food and drink outlets, if a low screen along the front garden perimeter wall is erected in order to protect clients dining in the front garden, it is to conform to the design provisions in Guidance G4 and Policy P7.

2.5 DEGREE OF ACTIVITY – ACCESSIBILITY AND MOVEMENT

A main shaper of street environments and a central contributor to street character is accessibility and movement. The requirements for vehicular movement need to be balanced against pedestrian safety and broader urban design considerations, which are in turn affected by such movement patterns.

2.5.1 Access for all

P11

ACCESS FOR ALL



All new developments should aim to provide an accessible environment for all, through design choices in relation to form, mass and layout of both the site and the building. The use of dropped kerbs at crossing points should be an essential element of all footway proposals, ramps should be used to enable better access into public buildings and tactile warnings should be given to partially sighted people of hazards or access points, in line with the provisions in Guidance G51.

To this effect, the Authority will require adherence to the policies and standards established by the National Commission for Persons with Disability (NCPD), for applications which are referred to NCPD in accordance to criteria as agreed between the Authority and NCPD.

While every effort should be made to provide full access-to-all even in scheduled buildings and areas, it may however not always be fully possible not to compromise the authentic heritage fabric of the area or building. In particular, attention should be given to the sensitive location of ramps such that they would not detract from the architectural value of a building. Furthermore, it would not be appropriate to remove original stone steps to enable better access.

2.5.2 Integration and accessibility of developments

New developments and redevelopments, particularly comprehensive and mixed-use developments, often offer the opportunity to be functionally integrated within the existing urban fabric by extending existing public access routes. Indeed, such improved accessibility often contributes to the increased viability of commercial developments.

G6

INTEGRATION AND ACCESSIBILITY OF DEVELOPMENTS



New developments and redevelopments should be physically integrated into their surroundings by creating, preserving and, where possible, extending links with existing public access routes. The design should encourage direct, safe and attractive connections between public transport, footpath and cycle routes and existing and proposed uses.

Safe and attractive public through routes, in terms of footpaths, cycle routes, streets and roads, which are appropriate to the scale of the development and related to existing desire lines, as well as any new ones arising from the development, should therefore be included within the design to maintain a well-connected, highly permeable network of secure routes

for pedestrians, cyclists, public transport users and motorists – and prioritise users in this order.

The layout within and around the development should be user-friendly, clear and legible in order to enable users and visitors alike to facilitate navigation and help people to understand where they are.

2.5.3 Pedestrian access to non-residential developments

P12

PEDESTRIAN ACCESS TO NON-RESIDENTIAL DEVELOPMENTS



The Authority will not normally grant permission for non-residential development in buildings also occupied by dwellings where a separate access to the non-residential use cannot be provided. This is due to the potential residential amenity issues that would arise with a common access, in terms of disturbance, noise and loss of security.

2.5.4 Vehicular access for all new developments

All access points used by vehicles should be **safe, easy and convenient to use**. This is achieved through Technical Standard S1 that establishes access widths (**Figure 30**) and Policy P13 that specifies a number of performance criteria to be fulfilled to ensure that this requirement is met, some of which are detailed further in subsequent provisions.

S1

VEHICULAR ACCESS WIDTH STANDARDS



The minimum width of the vehicular access required should relate to the design vehicles which would habitually use the vehicular accesses and the number and frequency of vehicles likely to use it. A width in excess of the minimum will therefore often be required for uses that have a high vehicular turnover or for larger vehicles. Typical access widths and functions are:

- a) 2.4 metres – one car access but not passing of other vehicles
- b) 3.7 metres – access by a fire tender
- c) 4.1 metres – 2 cars can pass each other
- d) 4.8 metres – a car and a lorry can pass each other
- e) 5.5 metres – two lorries can pass each other

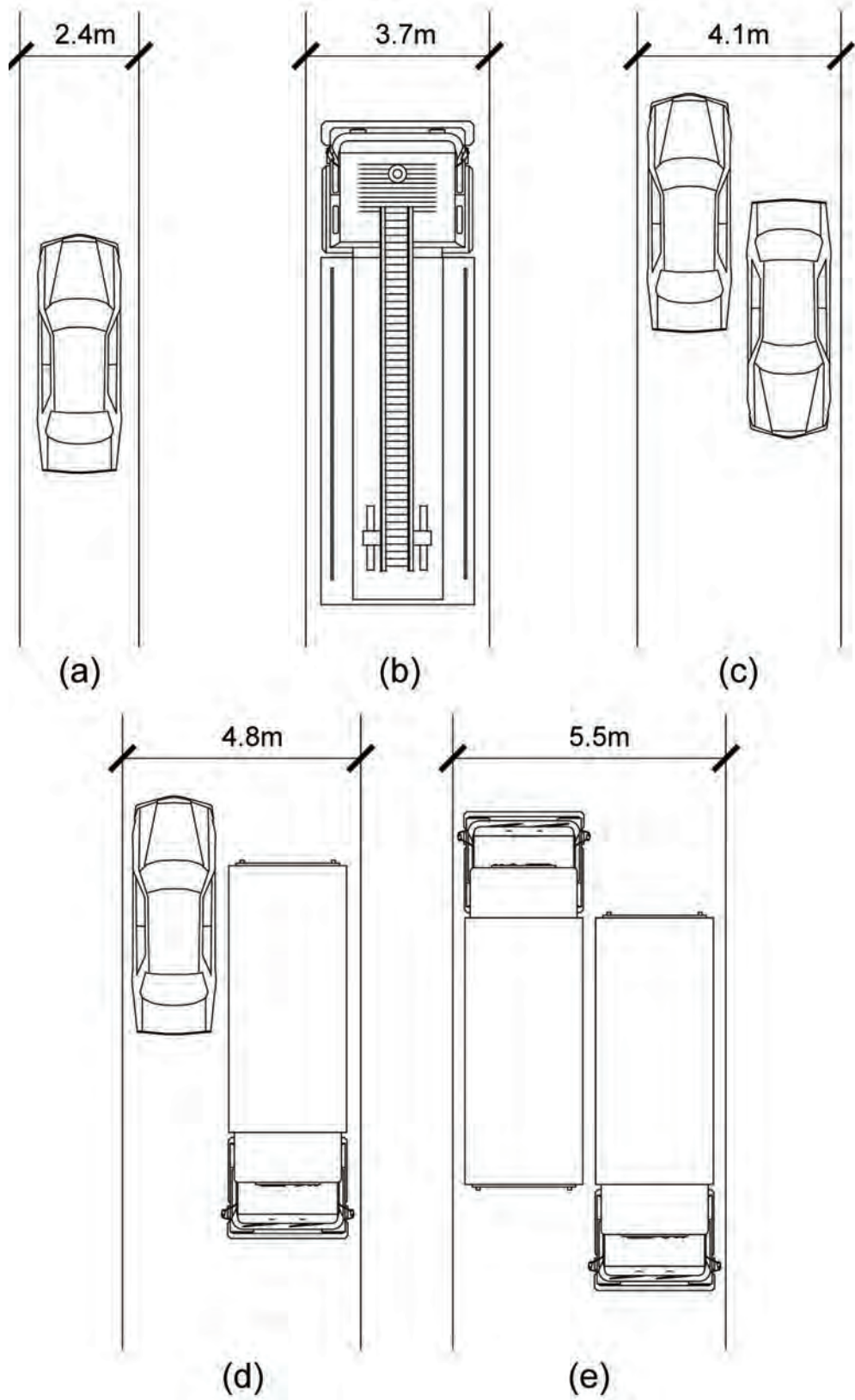

Figure 30: Vehicular access width standards

P13**VEHICULAR ACCESS FOR ALL NEW DEVELOPMENTS**

All new developments and redevelopments shall be provided with a suitable access route from an existing road or a road proposed in the Local Plan. In all cases, safety and convenience of all road users will be a prime consideration. The access must be designed and located to ensure that:

- a) *It will not materially reduce road safety, including motorists and vulnerable road users such as pedestrians and cyclists.*
- b) *Adequate visibility will be provided along both the carriageway and the footway for vehicles entering and leaving the development.*
- c) *It will not conflict with traffic flow, other road users and adjacent accesses.*
- d) *At developments where some form of entry control system is used, sufficient space will be provided for vehicles to wait clear of the public roadway and not obstruct vehicles emerging from the development.*
- e) *Adequate radii will be provided to enable vehicles to enter and leave freely without the need for additional turning or manoeuvring movements. To this effect, more than three manoeuvres will be considered to be inconvenient.*
- f) *Where the volume of vehicle movements justifies it and site conditions permit, a separate entry and exit and/or a separate vehicle and pedestrian access will be required.*
- g) *Landscaping and other built elements of the proposal will not hinder the use of the access. Potential obstructions to the visibility of motorists must be avoided, particularly those emerging from development. All landscaping, front garden walls and other obstructions within the visibility splay of the vehicular access will be lower than 1.05 metres (driver's eye height).*
- h) *Any vehicular access will relate to the width of the road and parking conditions along the said road, in order to be safe and convenient to use. Careful consideration is to be given when considering new vehicular accesses that would significantly reduce existing on-street parking provision.*

Where for overriding aesthetic reasons a vehicular access of 4.1 metres is undesirable, a reduced width may be considered. Nevertheless, regard should be given to the swept path of turning vehicles, and the safety and convenience of the access.

2.5.5 Access to and from arterial and distributor roads

Direct access from arterial and distributor roads is precluded in order that their function as major traffic arteries is maintained and safeguarded from development that might disrupt traffic flows or give rise to road safety issues.

P14**ACCESS TO AND FROM ARTERIAL AND DISTRIBUTOR ROADS**

No direct vehicular access will be allowed onto, or out of, arterial or distributor roads, as designated by the competent transport authority, unless such access is authorised by such authority.

Where an arterial or distributor road is flanked by a service road, then vehicular access to development will be designed to occur directly onto such service road, and from there, at

a limited number of points, onto the arterial or distributor road. In these cases, vehicular accesses will only be considered where vehicles may enter and exit the service road in a forward gear and in a single manoeuvre.

The conversion of existing ill-situated garage openings will be favourably considered provided that the replacement use does not result in an adverse traffic impact.

2.5.6 Access to non-residential developments – vehicular access

The separation of service areas and public car parks reduces inconvenience and potential danger, and improves efficiency. The individual accesses should also meet the requirements of other provisions in relation to accessibility and movement.

G7

VEHICULAR ACCESS TO NON-RESIDENTIAL DEVELOPMENTS



Access to parking areas of non-residential developments for use by the public (customers or other callers) and to on-site servicing (deliveries etc.) area should be segregated, unless the configuration or dimensions of the site are such that it is not safe or practical to do so.

Access to non-residential developments accommodating more than 5 vehicles should allow two vehicles to pass each other – minimum 4.1 metres – but if vehicles using the development are larger than a standard car these should reflect the dimensions specified in Standard S1.

2.5.7 Clear Access to Garages/Vehicular Accesses

Technical standard S2 sets out a minimum clear road width that must be available if garages/vehicular accesses are to be allowed (**Figure 31**). Garages/vehicular accesses must be capable of safe and convenient use. Access from a street of restricted width (by way of buildings, structures or on-street vehicle parking) is likely to give rise to potential danger for pedestrians and drivers because of the need for repeated manoeuvres when entering or leaving the garage/s.

S2

CLEAR ACCESS WIDTH STANDARDS FOR GARAGES



The Authority will only grant permission for the construction of garages where the street from which the access will be gained is as shown in Figure 31:

- a) *6.3 metres wide in the case of streets used for on-street vehicle parking;*
- b) *4.1 metres wide in the case of streets where on-street vehicle parking on the opposite side of the street to the garage(s) access is legally or physically prohibited; and*
- c) *except in UCAs, 4.1 metres wide in the case of streets where there is on-street vehicle parking on the opposite side and no footway adjacent to the garage, provided that the garage access is increased to a maximum width of 3.4 metres.*

The clear distance mentioned in this standard shall also take into consideration the standard pedestrian footway on either side of the road (albeit this may not have been constructed or is below prescribed standard). Where on-street parking on the other side of the road (fronting the garages/vehicular accesses) are allowed, this shall be taken into consideration and the geometrical standards have to be satisfied.

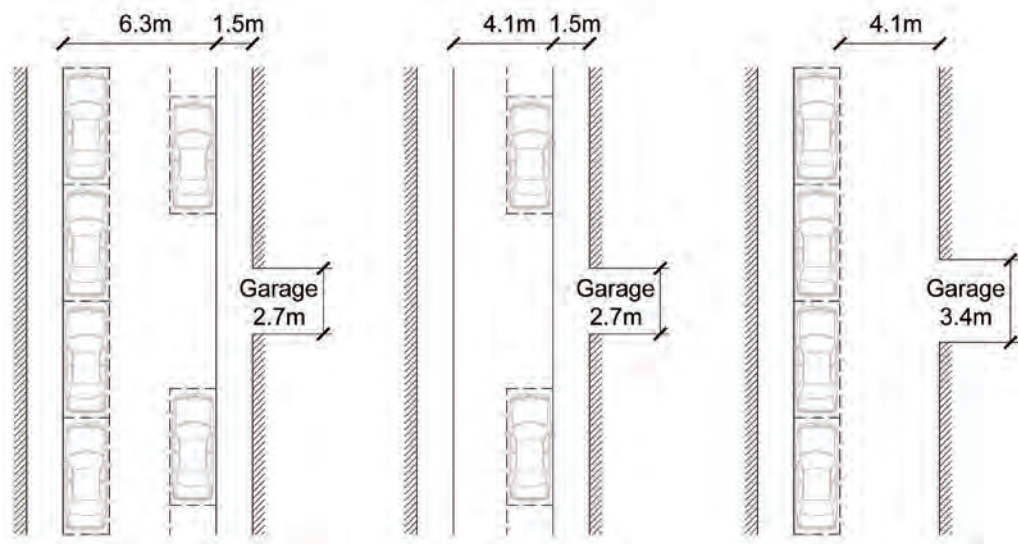

Figure 31: Clear access width standards for garages

P15

**VEHICULAR ACCESS
IN URBAN CONSERVATION AREAS**



In an Urban Conservation Area, when a new vehicular access is being proposed, a block plan will be submitted indicating any on-street parking, garage openings/vehicular accesses, the widths of pedestrian footways and carriageway and turning circles. Furthermore:

- a) *the minimum street width will follow the provisions in Standard S2;*
- b) *the width of the garage door will follow the provisions of Policy P20; and*
- c) *the clear distance in front of the garage/vehicular access will satisfy the criteria in Standard S4 for aisle widths (in this case clear distance) in relation to garage opening widths.*

2.5.8 Junctions and development accesses

Radii at junctions determine the ease with which vehicles can enter and leave a side road or access. The appropriate radii will be determined by various considerations and Guidance G8 provides some general pointers with regard to appropriate radii.

G8

JUNCTIONS AND DEVELOPMENT ACCESSES



Radii at junctions/development accesses should be sufficient to accommodate turning by the type of vehicle that the junction/access is predominately intended to cater for, and will be determined by the width of the access to major development sites, the volume of turning movements, and the type of vehicles using the access. As a general guide:

- a) A 4 metre-kerb radius is appropriate in residential areas, where the priority and non-priority roads are at least 5.5 metres wide and the non-priority road/access has modest traffic flows.
- b) A 6 metre-kerb radius is appropriate at busier junctions/accesses, where a refuse collection vehicle is likely to be the largest vehicle regularly requiring access.

While having regard to established scheme alignments, where necessary, buildings and boundary walls should be splayed or rounded off using designs that safeguard the appropriate radii and footway widths. In some circumstances, mountable shoulders (overrun area) can be used to facilitate the easy movement of larger vehicles, whilst limiting speeds and avoiding over engineered designs. As a minimum, corner splays need to take account of minimum radii and footway width requirements.

Vehicular accesses in the vicinity of junctions should be safe to use and not pose a danger to other road users, and so should be at least 4 metres from junctions, corners or bends as indicated in Figure 32. This is to ensure that vehicles emerging from them will have visibility of oncoming vehicles, and similarly drivers turning round a corner or bend will have forward visibility of vehicles leaving or waiting to enter the access. The distance given in this policy is a minimum that will be appropriate within built up areas where traffic speeds are generally low.

Where a vehicular access is proposed in a cul-de-sac or alley where traffic flows are low, this requirement may be relaxed provided that there is no adverse impact on road safety.

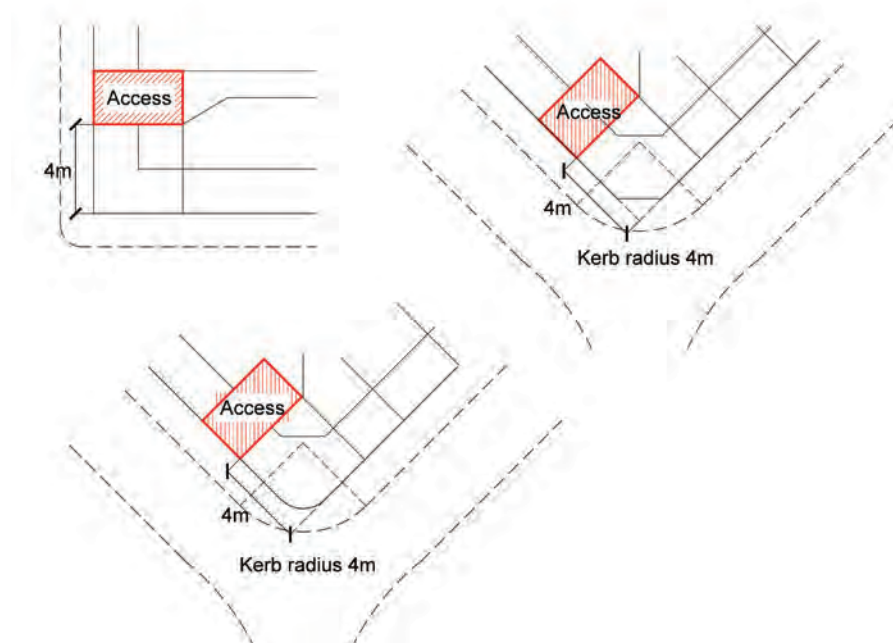

Figure 32: Junctions, corners and bends – possible scenarios

2.5.9 Access for Fire Tenders

Developments should be designed to ensure easy access for fire tenders needing to attend a fire.

P16 ACCESS FOR FIRE TENDERS



Where developments need to be designed to ensure that a fire tender can gain unhindered access, a certificate endorsed by a competent professional Warranted Engineer will be provided. Fire access will normally be to the front of dwellings although rear access may be accepted.

2.5.10 Waiting Areas

Where vehicles will use an access ramp, it is important that these are able to wait conveniently and safely to enter the street.

S3 STANDARDS FOR WAITING AREAS



An area of a depth of 4.8 metres from the pavement, with a gradient not steeper than 1:10, will be provided within the site (within the building or by setting the access part of the building back from the street alignment) for vehicles to wait at pavement level before entering the street. There may be circumstances whereby in order to aid driver visibility a splayed access may be provided.

2.6 DEGREE OF ACTIVITY – PARKING AREAS AND GARAGES/VEHICULAR ACCESSES

The provision of adequate levels of parking is important but it is equally important that new developments, any change of use of whole or part of existing developments and/or modifications to existing developments have well-designed layouts for such parking areas.

G9 PARKING AREAS – GENERAL DESIGN CONSIDERATIONS



Parking areas should be user friendly, safe and convenient to use. When planning parking areas, the focus should not be limited solely to satisfying the geometrical Technical Standards in this document, but due consideration should also be given to:

- How parking bays, garages, vehicular accesses, loading/unloading bays interact with each other, plot configuration, size, type and scale of the development.
- The safety and security of parking layouts in terms of design against crime and the accommodation of the safe passage of emergency, delivery and refuse collection vehicles, if this is deemed necessary.
- The location of parking areas and proximity to accesses, including accessibility for all requirements.

- Avoiding the obstruction of parked vehicles that would otherwise have to be displaced in order to allow for vehicle entry/exit.
- Important sight lines and manoeuvring requirements, particularly due to the structural constraints of underground parking areas.
- The requirements of emergency and other service vehicles.

2.6.1 Parking areas, parking spaces and garages

The fundamental technical standards related to parking areas, parking spaces and garages are provided in **Figures 33** and **34** together with **Tables 2, 3** and **4** hereunder. These standards ensure that car parks, parking spaces, garages and aisles are of sufficient width to function properly in the interest of safety and convenience of the users.

S4

STANDARDS FOR PARKING AREAS, PARKING SPACES AND GARAGES



Parking area layouts, parking spaces and garages will satisfy the minimum standard dimensions of the design vehicle associated with the proposed development to ensure proper functioning. These dimensions will be used as standard although occasional variations may exist, such as for smaller environmentally friendly vehicles. The absolute minimums apply where sites are restricted.

- Figure 33 illustrates the terminology used to describe the different aspects of parking layouts.
- Table 2 sets the standard dimensions for different vehicle categories.
- Table 3 establishes the standards for cars parked at different angles.
- Table 4 shows minimum dimensions for residential garage areas.
- Figure 34 illustrates typical swept paths for these vehicles when turning.

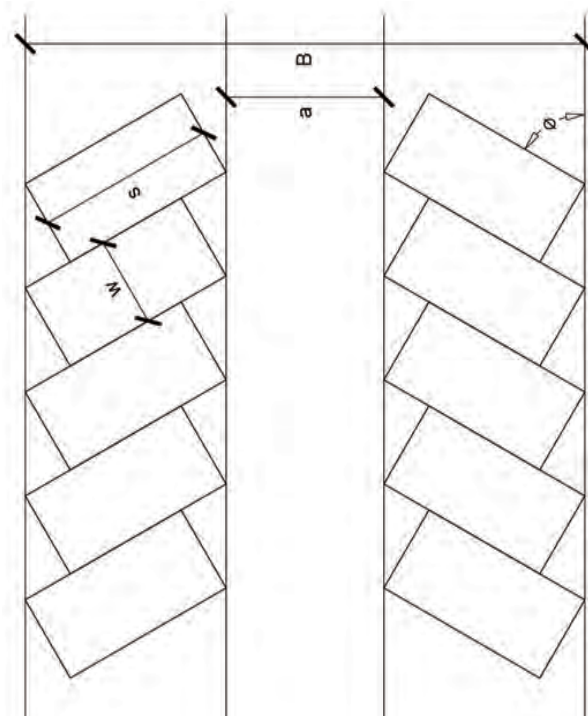

B = Bin Width,
 a = Aisle Width,
 \varnothing = Parking Angle,
 w = Parking Space Width,
 s = Parking Space Length

N.B. For 90-degree parking:
 $l = w, d = s$

Figure 33: Different aspects of Parking Layouts

Vehicle Type	Car	Light Van/Coach/Bus Rigid		Heavy Goods Vehicle	
				Articulated	
Vehicle Dimensions (m)	4.5 X 1.8	Up to 5.5 X 2.1	Up to 12.0 X 2.5	Up to 11.0 X 2.5	Up to 16.5 X 2.5
Allocated Parking Space (m)	4.8 X 2.4	6.0 X 2.3	14.0 X 3.5*	14.0 X 3.5	18.5 X 3.5

* Note: Where boarding and/or alighting will take place from a coach/bus parking space, the width will be increased to at least 4.5m.

Table 2: Typical Parking Space Requirements

Parking Angle (°)	Aisle Width (a)		Parking Space Width (w) (m)	Bin Width (B) (Parking Space length (s) 4.8m)	
	Absolute Minimum (m)	Standard (m)		Absolute Minimum (m)	Standard (m)
90	Two-way aisle * 6.95	Two-way aisle * 6.95	2.40	16.55	16.55
90	One-way aisle * 6.00	One-way aisle * 6.00	2.40	15.60	15.60
80	5.25	5.25	2.40	15.45	15.45
70	4.50	4.70	2.40	15.08	15.28
60	3.75	4.20	2.40	14.39	14.84
50	3.50	3.80	2.40	13.87	14.17
45	3.50	3.60	2.40	13.62	13.72

Notes: For parallel parking a minimum aisle width of 3m is acceptable. Where parking bays are parallel to the wall or kerb these should be 6m long and have a clearance of at least 3m to allow for easy manoeuvring in and out of parking.

* In residential developments an aisle width of 6m is acceptable for two-way movements.

Table 3: Recommended Parking Dimensions for communal car parking areas

Garage Dimensions (m)				Aisle Width (m)
Width	Length	Height of Opening	Width of Opening	
2.7	5.1	2.1	2.4	6.00
			2.5	5.90
			2.6	5.80
			2.7	5.70
			2.8	5.50
			2.9	5.30
			3.0	5.00

Notes: These are 'clear' dimensions excluding wall thickness.

In the case of closed garages in parallel, the end garage should have a clear width of 3.3m in order to facilitate the turning circle of the vehicle into such garage.

Table 4: Recommended Minimum Parking Dimensions for Garages in Residential Developments

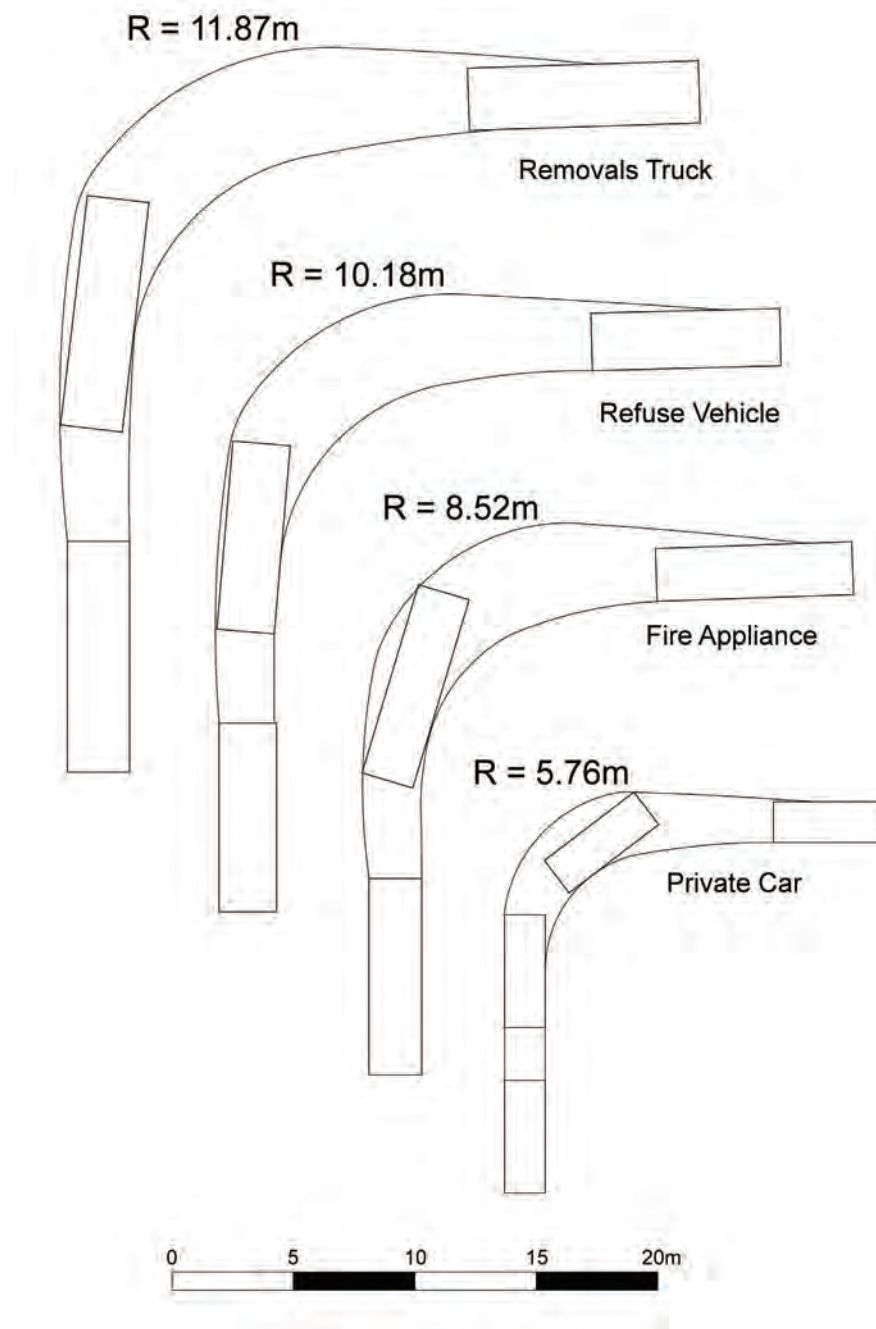

Figure 34: Radii and swept paths diagram

2.6.2 Headroom requirements

Headroom heights apply to all parts of parking areas, and include entrances and exits, parking spaces, and aisles and ramps but exclude space for service requirements such as ducting and lighting. The internal height of private garages is also included in this Technical Standard.

S5

HEADROOM STANDARDS IN PARKING ENVIRONMENTS



The following minimum headroom standards will apply in new developments:

- Minimum vertical clearance (headroom): 2.1 metres at the access point.
- Public car parks: minimum headroom of 2.1 metres will be required.
- Parking areas accessible by fire tenders: minimum headroom of 3.5 metres will be required.
- Heavy goods vehicle (HGV) loading and parking areas are under cover: minimum headroom of 4.65 metres will be required.

With regard to the internal height of garages (which form part of buildings) for the parking of private vehicles: minimum dimension of 2.1 metres clear of structural beams and not exceeding 3.4 metres to the underside of the structural slab.

2.6.3 Underground Parking Areas – Domestic Stores

P17

UNDERGROUND PARKING AREAS – DOMESTIC STORES



Domestic stores in underground parking areas will be acceptable in principle as long as they will:

- be used exclusively for domestic storage – any other use is not acceptable;
- have an access width of not more than 1.5 metres; and
- not have a direct access onto a public road.

2.6.4 Parking provision and typology

P18

PARKING PROVISION AND TYPOLOGY



For both residential and non-residential development there will be a concerted effort to provide on-site parking in line with the Vehicle Parking Standards provided in Annex 1 to this document. This will be particularly enforced in residential areas. If this is physically and technically unfeasible/impossible, or undesirable, there will subsequently be a contribution to a Commuted Parking Payment Scheme (CPPS)/Urban Improvement Fund (UIF). Specifically, in comprehensive industrial developments or for industrial developments involving more than a single plot, there will always be an allowance for parking provision, which will furthermore be located underground and designed as part of the entire industrial development.

In areas where CPPS or UIF are applicable, the loss of parking provision may be compensated for by a contribution established by the Authority towards either of these schemes.

In the case of non-residential developments the parking provision will be in the form of communal (open) parking spaces, rather than lock-up garages, to facilitate their use by customers, other visitors and employees.

Where it serves more than 15 spaces, the access width of such communal car park will be not less than 4.1 metres.

In all cases permits issued will be conditional so as to preclude any change of use that may give rise to new parking requirements without notification to the Authority.

2.6.5 Turning Space and Internal Circulation

G10 TURNING SPACE AND INTERNAL CIRCULATION



In parking areas for non-residential premises with more than 5 vehicles and for residential developments with 15 or more spaces or where the vehicular access leads directly onto a busy road, sufficient turning space must be provided within the site to allow all vehicles to leave and re-enter the road in a forward gear so as not to be hazardous to pedestrians or other vehicles using the street and disrupt traffic flow.

Vehicles should be able to enter and leave all garages/vehicular accesses and parking spaces independently from other parked vehicles in order to ensure that parking spaces are convenient and effectively used. The site should be designed so that only simple vehicle manoeuvres are required with no more than three movements.

G11 OBSTRUCTION OF EMPLOYEE PARKING IN NON-RESIDENTIAL DEVELOPMENTS



There may be instances, in non-residential development, whereby some employee parking may be obstructed, provided that the operation is not compromised and that parking areas are still safe and convenient to use for servicing, deliveries and clients. As a general guide, this should not exceed the lower of 15% of the parking provision or 10 vehicles.

2.6.6 Ramps – gradients, radii and widths

This Technical Standard ensures that ramps serving basement parking areas or garages/vehicular accesses have an adequate gradient, radius and width so that they are safe and convenient to use, particularly within garages or car parks with large volumes of vehicle movements.

S6 RAMP STANDARDS – GRADIENTS, RADII AND WIDTHS



Ramp gradients

Parking for residential developments which serve less than 15 parking spaces serving exclusively private car parking spaces or garages shall not be steeper than 1:5 from the back edge of the pedestrian footway.

In all other developments including public car parking spaces/garages, the gradient of a ramp serving not more than 5 car parking spaces shall not be steeper than 1:5 from the back edge of the pavement. Similarly the gradient of a ramp/s serving more than 5 car parking spaces shall not be steeper than 1:8 where the ramp is straight and 1:10 where the ramp is helical, from the back edge of the pavement.

Ramp radii and widths

The inside radius of helical ramps or bends should be at least 4 metres, as indicated in Figure 35.

Shared driveways/ramps longer than 15 metres, where the ends are not intravisi-ble, or those serving more than 15 parking spaces, should be at least 4.1 metres wide. In all other cases, ramps should be at least 2.4 metres wide. The minimum width of the ramp required should relate to the design vehicles which would habitually use the vehicular accesses and the number and frequency of vehicles likely to use it. A width in excess of the minimum will therefore often be required for uses that have a high vehicular turnover, or larger vehicles, so as to ensure that two vehicles are able to pass each other this must be done without difficulty or the need for additional manoeuvring.

Helical ramps or ramps that include bends should accommodate the swept paths of two vehicles passing each other, as indicated in Figure 35. An absolute minimum width of 6 metres is required for helical ramps or at bends. Where a separate access and exit arrangement exists a width of 3 metres for one-way helical ramps will be acceptable.

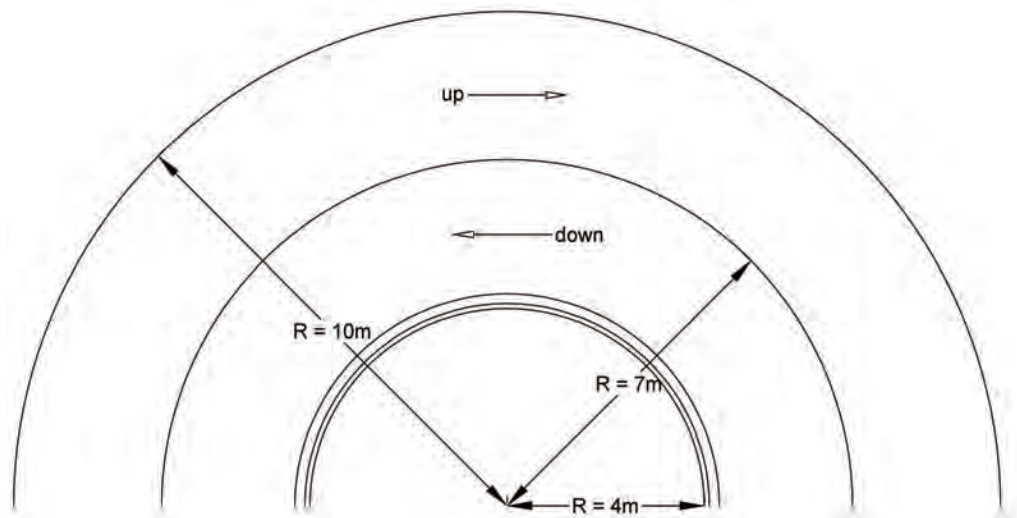

Figure 35: Absolute Minimum Dimensions for Helical Ramps

2.6.7 Garage door openings

This policy is related to Technical Standard S2 and to its objectives.

P19

RESIDENTIAL GARAGE DOOR OPENINGS



Residential garage door openings shall not be higher than 2.8 metres and shall have a minimum width of 2.4 metres, its width varying depending on:

- a) *the parking limitations;*
- b) *the street width, where the garage is proposed to be located as shown in Figure 31; and*
- c) *the visual implications with regard to aperture proportions and orientation, solid: void ratios, which are to be studied in the context of the entire streetscape and other openings present therein.*

P20

GARAGE DOOR OPENINGS IN URBAN CONSERVATION AREAS



Garage door openings in UCAs are to meet the criteria established in Policy P19, except that they are to be between 2.4 metres and 3 metres wide, provided that they would not be visually dominant and not have an adverse impact on the streetscape and on the character of the surrounding area, which is to be maintained and enhanced. Notwithstanding this, proposed widths in excess of, or less than, 2.4 metres will only be considered once it may be established with certainty that the opening's proportions are in harmony with the façade.

Garage door openings are also to respect the provisions in Guidance G43, particularly with regard to ensuring a vertically oriented proportion. In this respect, arched openings higher than 2.8 metres having a fanlight may be considered if the ground floor height allows the inclusion of such proportion. Any such interventions must be in harmony with the architectural proportions of the façade and no architectural elements and/or features of the façade are to be compromised.

Garage openings at a setback from original street alignments, whether at ground level or below, will not normally be permitted. However, there may be cases where a basement garage with a minimum height of 2.4 metres above street level and a short ramp behind the garage door on the original street alignment may be considered, provided that:

- a) *the garage opening is on the street alignment;*
- b) *the overall height of the proposed building does not exceed the height limitation as designated within the Local Plans; and*
- c) *the main door to the dwelling unit is not reached by an exposed flight of steps – that is, only two to three steps will be allowed on the street elevation.*

No alterations to façades of Grade 1 and Grade 2 buildings will be permitted for the provision of garages. Alterations to façades of Grade 2 buildings will not normally be allowed. Exceptions may be made if a very high standard of design is achieved as detailed below. The provision of domestic garages in Grade 3 or incongruous buildings may be allowed, provided that:*

- a) *the criteria established in Policy P19 as well as the opening dimensions as detailed above are respected;*
- b) *the proposed opening does not disrupt the façade proportions or impact negatively on any architectural elements and/or features; and*
- c) *the materials used and the colour of such opening is in line with the provisions in Guidance G50 and G52 respectively.*

2.6.8 Garages for private vehicles

P21

GARAGES FOR PRIVATE VEHICLES – GENERAL CONSIDERATIONS



The Authority will ensure that garages and communal parking spaces intended to provide public or (particularly) private off street parking will only be used for the short-term garaging of private vehicles and not for the garaging of heavy goods vehicles, as defined in the Glossary of this document, other than those intended for servicing the development in specific instances. The parking of commercial vehicles that fall outside said definition will be acceptable.

The Authority will impose a condition to this effect on all development permissions which include provision for public or private off street vehicle parking.

2.6.9 Garages for private vehicles – detached and semi-detached dwellings

P22

GARAGES FOR PRIVATE VEHICLES – DETACHED AND SEMI-DETACHED DWELLINGS



A garage will not be allowed in the side curtilage of a detached or semi-detached dwelling, if such dwelling will be allowed to develop a Type 3 basement level, in line with Policy P38. A carport may nonetheless be allowed in line with the provisions in Policy P9.

A garage will be allowed in the side curtilage of a detached or semi-detached dwelling:

- a) *where a Type 3 basement level is not being proposed;*
- b) *where a Type 3 basement level will not be allowed; or*
- c) *in the case of a redeveloped detached or semi-detached dwelling that is located within a streetscape characterised by garages within the side curtilage, provided that the streetscape character of these areas is not compromised (Figure 36).*

Specifically:

- a) *the garage shall not exceed an overall height of 3 metres measured from the finished pavement level of the building;*
- b) *the garage is to have an internal clear depth of not less than 5.1 metres in line with Standard S4 (Table 4);*
- c) *the façade of the garage shall be setback 4.8 metres from the building alignment;*
- d) *there shall be no permanent access to, or use of, the roof of the garage – in particular, no services will be allowed on the roof of the garage; and*

- e) *the garage shall be of such a size that it does not detract from the overall character of the dwelling.*

The provision in (e) above should furthermore allow the establishment or maintenance of planting and hard/soft landscaping commensurate with the existing character of the site and the surrounding area.

A minimum of two car parking spaces will be provided on site. The application of the Urban Improvement Fund will not be applicable in this type of development, unless it is physically impossible to provide parking for the dwelling.



Figure 36: Garage within the side curtilage

2.6.10 Garages for private vehicles – internal garages

P23

GARAGES FOR PRIVATE VEHICLES – INTERNAL GARAGES



Except for industrial areas, no internal garages will be allowed beyond a depth of 30 metres measured from the building alignment. Within the 30-metre depth internal garages will be allowed, except for Urban Conservation Areas, residential priority areas and residential areas located in sensitive environmental locations, such that private open space that contributes to the character of these areas (including gardens and other backland) may be protected from development.

Where allowed, internal garages shall not be roofed over more than 2.6 metres above internal street level.

Development over internal garages will only be allowed where the forecourt and driveway(s) will be roofed over. These interventions will only be allowed if:

- a) *they will have a public frontage on a street (a public or schemed road);*
- b) *they are in keeping with the character of the area;*
- c) *they are compatible in scale, design and form with any adjoining property;*

- d) *a satisfactory layout can be provided that provides an adequate standard of privacy and outlook; and*
- e) *they would not have an adverse impact on the amenity of buildings adjoining the site, particularly outlook and privacy.*

Where the forecourt and driveway(s) cannot be roofed over, allowable development over the internal garages will only comprise:

- a) *extensions to existing development, as long as such extensions are internally connected;*
- b) *landscaping works aimed at reinstating its spatial value within the urban area by knitting such open space to the rest of the urban fabric, in line with the provisions in Guidance G41; and*
- c) *the extension to external yards/terraces of existing surrounding developments.*

In areas zoned by the Authority for industrial development, or in an area predominantly (legally) devoted to industrial or warehouse uses, development over internal garages will be encouraged in order to make effective use of the available land that may provide useful additional industrial, warehousing/storage or ancillary space. Such industrial development (or development ancillary to industrial uses) over internal garages will comprise the garaging of private cars and will normally be allowed provided that:

- a) *the development is in keeping with the character of the area;*
- b) *the development would be compatible in scale, design and form with adjoining property;*
- c) *a satisfactory layout and building form can be provided; and*
- d) *satisfactory access arrangements can be achieved.*

2.6.11 Garages for Heavy Goods Vehicles and Public Service Vehicles

P24

GARAGES FOR HEAVY GOODS VEHICLES AND PUBLIC SERVICE VEHICLES



No garage(s) for the garaging/parking of heavy goods vehicles and buses/coaches will be permissible in Urban Conservation Areas, Local Centres, Residential Areas including seafront locations), Residential Priority Areas, or Residential Areas located in environmentally sensitive locations, as they would have an adverse impact on the character and appearance of these areas.

In non-residential areas, the Authority may allow garage(s) for the garaging/parking of heavy goods vehicles and buses/coaches so as to provide for the off-street garaging of heavy goods and public service vehicles that would otherwise be unsightly to the streetscape and could furthermore be dangerous due to the space required for their manoeuvring. Garaging these larger vehicles can therefore increase the general amenity of these areas.

Specifically:

- a) *The proposed development would not have an adverse impact on the residential amenity of the occupiers of dwellings in the area or on the character of the area because of noise, disturbance and reduced air quality or traffic generation.*
- b) *The road network serving the site is capable of safely and conveniently*

accommodating the volume of heavy vehicle movements generated by the development.

- c) The type and size of heavy vehicle(s) will have to be specified and the turning circle(s) will need to be calculated specifically according to the typology of such heavy vehicle(s), to ensure that the vehicle can enter and exit the garage without the need to make traffic management changes.

In Residential Areas public service vehicles may be garaged within parking areas dedicated to residential parking only if:

- the residential parking will be left unencumbered and will be allowed priority to enter and exit the garage; and
- there will be a maximum capping of 5 parking spaces allocated for such vehicles.

The design of the garage(s) shall meet the following criteria:

- i) the overall internal height of the garage(s) should not exceed 4.3 metres to the underside of the structural slab, measured from lower pavement level and no ramps down are allowed;
- ii) the maximum height of the doorway will be 4 metres and the maximum width will be 4 metres; and
- iii) the garage(s) will be used only for the parking/garaging of vehicles and will not be used for any commercial or industrial purposes.

Where garages for heavy good vehicles are being proposed, a scaled block plan will be required, showing the entire width of the street, including any on-street parking spaces. If acceptable, the permit will include a condition which will specify that no heavy goods vehicles bigger than the size indicated in the plans will be allowed in the garage. The clearance from the competent authority will be required to ensure that the width of the street in front of the garage, including any parking spaces which are on the street, will allow the specified size of heavy vehicle to enter and exit the garage safely.

2.6.12 Garages for self-drive hire cars

G12

GARAGES FOR SELF-DRIVE HIRE CARS



It is envisaged that the garaging of self-drive hire cars would most likely pose few amenity problems, because of the smaller vehicle size and the potentially limited number of vehicle movements. For this reason, the Authority may grant permission for public service garage(s) for self-drive hire cars subject to criteria (a), (b), (i) and (ii) specified in Policy P24.

Garage(s) for single self-drive hire cars may also be allowed within Urban Conservation Areas, where their use is likely to be the same as that of an ordinary domestic car. In such cases, the provisions in Policy P20 will bind the dimensions for the garage door openings.

2.6.13 Car Lifts

Car lifts can provide the means of access to off-street parking in situations where the space for ramped access is limited. However, they are inappropriate where the off-street parking area is to serve a large number of visitors, as customers of shops or callers to offices. Lifts normally allow use by only one car at a time and so would give rise to queuing in those situations where vehicle movements are considerable.

P25

CAR LIFTS



The Authority will only allow a car lift as the sole means of access to off-street parking areas for small-scale residential developments or for non-residential developments, where the parking areas are not intended to be accessible to a large number of frequent visitors and the site is restricted in size or shape such that a normal ramped access cannot be provided.

It is important that car lifts are well positioned and designed; that they can be accessed and exited without danger or inconvenience to other road users or to pedestrians; that they are easy to use; and meet a number of other performance standards and requirements addressed hereunder.

Where allowed, the access to the car lift shall comply with the other access requirements set out in Policy P13 and with the following criteria:

- a) *Each lift will not serve more than 20 vehicles in total.*
- b) *A 4.8-metre waiting area will be provided within the site at the entrance/access to the lift from the road.*
- c) *The visibility from the entrance/access along the road, and the internal visibility to the car lift will be adequate.*
- d) *Waiting areas will be provided at all car parking levels served by the car lift.*
- e) *Adequate internal circulation and manoeuvring space will be provided so that the lift can be used easily and safely.*
- f) *The lift will be located within the site, and adequate turning space is provided, so that ideally cars can enter and leave the site in a forward gear.*
- g) *The lift will be of adequate dimensions and at least 2.4 metres clear door opening by 4.8 metres clear depth.*
- h) *The operation of the lift will be straightforward and suitable safety measures, such as guardrails and warning signs (both audible and visual), will be provided.*
- i) *A secondary pedestrian access and escape will be provided.*
- j) *A secondary source of power to the car lift will be provided.*

Applications for development including car lifts are to include information and/or plans and drawings endorsed by a Warranted Engineer that clearly demonstrate that the criteria in the policy have all been met. Furthermore, a condition will be imposed requiring the lift to be installed, operational and certified by a Warranted Engineer before a compliance/completion certification is issued.

2.6.14 Landscaping in Parking Areas

Surface level car parks may often be visually uninteresting with large areas of unrelieved hard surfacing, and well-designed landscaping can do much to add interest and reduce any negative effects.

G13

LANDSCAPING IN PARKING AREAS



*Landscaping should be used in surface level car parks to relieve the monotony of large tarmac/paved areas, guided by the provisions in Guidance G41. As established in Policy P13, planting should not obscure sight lines at junctions or reduce the effective length or width of the parking spaces. The design of such landscaping should be appropriate to the site location and the context, and may consist of grass, ground cover plants, shrubs and trees that are pollution-resistant and, in the case of trees, not liable to heavy leaf-fall or fruit dropping. Further guidance on appropriate species is given in **Guidelines on Trees, Shrubs and Plants for Planting & Landscaping in the Maltese Islands (MEPA, 2002)**.*

Surface level car parks should also provide the opportunity to house new technologies, such as shading devices for vehicles that are furthermore fitted with solar cells/panels in order to double up as energy-generating centres, in line with the provisions in Guidance G25 (Figure 37).



Figure 37: Landscaped surface parking area (left); car parking shading structures that double up as energy-generators (right)

2.7 CONTEXTUAL DESIGN – QUALITY CHECKLIST FOR *PERITI*, ASSESSORS AND DECISION-MAKERS

Initial questions

- Does the development contribute to the character sought for the area? Does it reinforce local distinctiveness?
- Has an analysis of the existing context, including a streetscape analysis, been carried out? Has such analysis been used to inform the design interventions?
- Does the development seek to respect and enrich its existing context by positively contributing to a new or existing sense of place?

Setting – Natural features

- Should the development fit into a natural landscape setting or settlement form and, if so, does it relate to the features that define such setting?
- Does the built form relate to the character of the wider landscape context in terms of the topography, the character of ridges and edges and visual prominence? Have characteristic features worthy of retention been identified and protected?
- Does the design take on board specific characteristic landscape patterns and features? Does it effectively seek to mitigate any negative features that detract from the character and quality of the site?
- Does the design utilise existing site levels and contours to prevent excessive cut and fill? Does it follow the existing topography?

Setting – Built features: streetscape character

- Is it appropriate to harmonise with the context or deliberately to contrast with it?
- Does the design respect suitable height to width ratios that enrich the visual and experiential qualities of the street context?
- Does the development create a good transition to the neighbouring buildings, in terms of height, size and scale?

Setting – Built features: front, side and rear garden boundary walls

- Does the front garden provide a suitable and interesting interface between the public and private spaces?
- Is the front garden boundary wall adequately designed in terms of height, materials and details? Does it allow for spatial enclosure and does it contribute positively to the street character?
- Does the front garden contain a good planting and landscaping scheme that provides a positive contribution to the street and that furthermore reflects the local species?

Setting – Degree of activity: accessibility and movement

- Is the development accessible to all?
- Are there movement routes around the site or through it that should be retained or created?
- Does the development integrate footpaths, cycle routes, street and roads into a well-connected, permeable network of routes that encourages green modes of travel and facilitates access to public transport?
- Have the key technical standards and performance criteria in relation to accessibility and vehicular movement been followed?

Setting – Degree of activity: parking areas and garages/vehicular accesses

- Are parking areas user friendly, safe and convenient to use?
- Do the parking areas, spaces and garages follow the technical standards in relation to space requirements, parking dimensions and vehicular accesses?
- Have swept paths for the vehicles in question been checked in terms of accessibility?
- Are garage door openings adequate from both a functional and visual point of view?
- Do garages respect the contexts wherein they are located and have the key technical standards and performance criteria been followed?



03

URBAN FORM

- 3.1** URBAN GRAIN AND BUILT FORM
- 3.2** SPATIAL ENCLOSURE – BUILDING LINE, FAÇADE PROPORTION AND BUILDING HEIGHT
- 3.3** GROUND FLOOR TREATMENT
- 3.4** SETBACK FLOORS AND HORIZONTAL ADDITIONS
- 3.5** URBAN FORM – QUALITY CHECKLIST FOR PERITI, ASSESSORS AND DECISION-MAKERS

The scope of **Part 3** is to establish the basic and fundamental design parameters that define the street and that contribute to its character and spatial quality. This Part builds on from the contextual considerations and basic design parameters established in Part 2, such as the regard to existing topography, the human scale and field of vision and the relationship between building height and street width. It furthermore provides a further layer of detail on which architectural considerations may be subsequently developed further within Parts 4 and 5 of this document. Ensuring the correct urban form is critical to the success of a street. With this knowledge, the majority of provisions in Part 3 are policies and it will be expected that *periti*, assessors and decision-makers adhere to the criteria established therein.

The Part commences with issues in relation to urban grain and built form (Section 3.1), including aspects in relation to site coverage and plot/site frontage; critical design issues in relation to spatial enclosure (Section 3.2), including building line, façade proportion and building heights; key parameters to be taken on board with regard to the treatment of the ground floor, including basement levels (Section 3.3); and qualitative and quantitative considerations regarding setback floors and horizontal additions (Section 3.4) (**Figure 38**).

3.1 URBAN GRAIN AND BUILT FORM

The starting point of any development should be closely based on the existing urban grain that characterises the context wherein it is developed.

G14

REGARD TO EXISTING URBAN GRAIN AND BUILT FORM



In line with Guidance G3, the predominant parameters arising out of the streetscape analysis and street photographic survey are to be taken into account within the eventual design outcome of the proposed development, which may or may not be dictated by the existing context.

Where it is clear that such context has been developed otherwise than in accordance with requirements set out within the provisions for urban form, new development located within the block, street or neighbourhood should endeavour to conform to the pattern set by the existing adjoining development and/or the requirements and conditions that have been applied to such development, so as to maintain the character of the area.

The above will not be applicable if the existing adjoining development contradicts some fundamental parameters that are negatively contributing to such context.

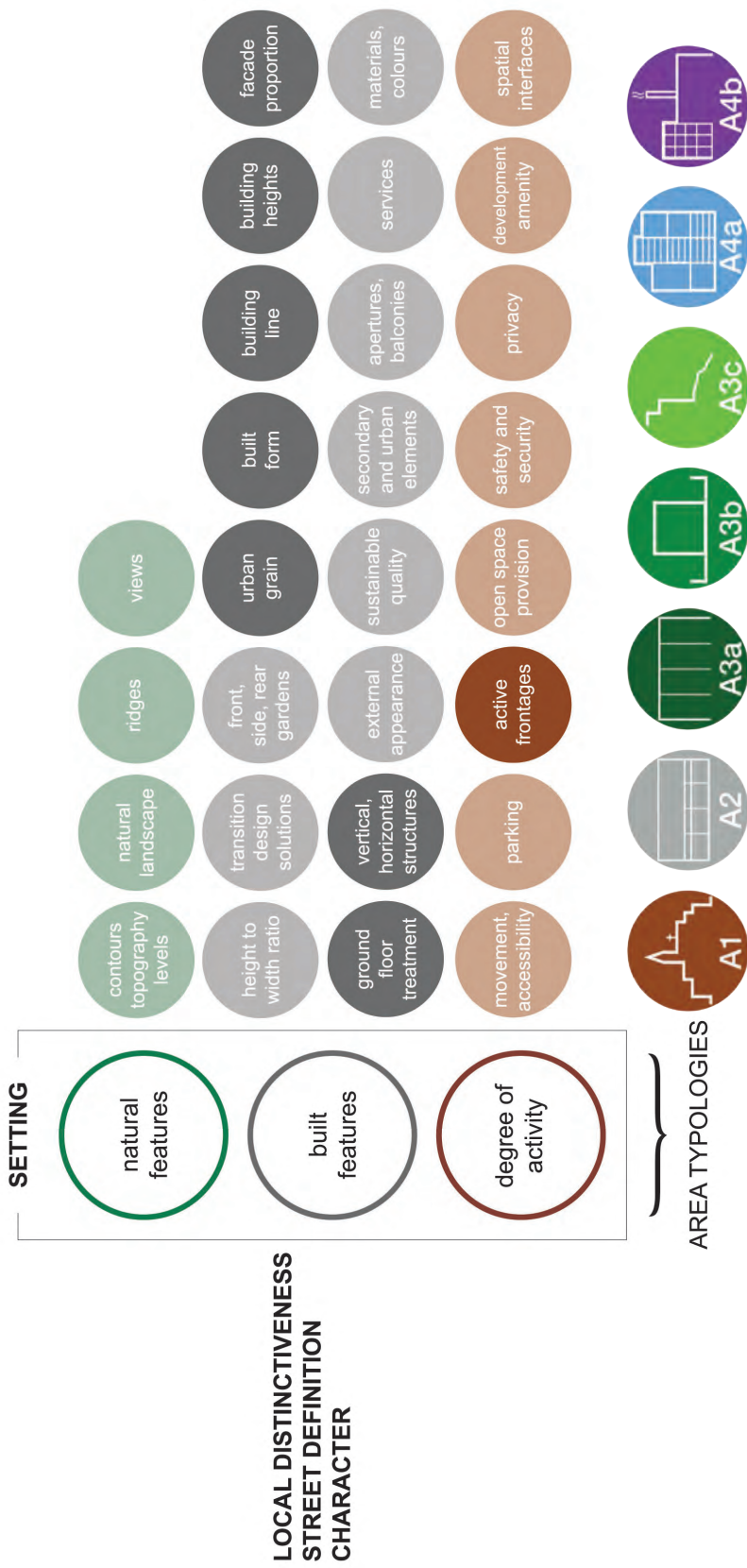

Figure 38: Contributors to setting, local distinctiveness and streetscape – the remit of Part 3 is highlighted

3.1.1 Plot size

A fundamental contributor to urban grain is plot size, which is determined by the site frontage and allowable development depth. Standards for detached and semi-detached dwellings, in terms of plot size, are further discussed in the next section.

P26

SITE FRONTAGE



New development

In the parcelling of new developments, the site frontage will not be less than:

- 6 metres in the case of terraced residential developments; and
- 9 metres in the case of detached and semi-detached dwellings, such that adequate natural light and ventilation can be provided from the front of the building/dwelling and an adequate access can also be provided.

Residual development

In the case of residual sites, or where a site is of an irregular or restricted shape such that the minimum frontage cannot be provided, the potential resultant development will be assessed using the same criteria for transition design solutions, in line with the provisions in Policy P6.

In order to safeguard residential amenity and to ensure a reasonable standard of internal living environment, the residual development will:

- Have a site frontage that is not less than 4 metres in the case of terraced residential developments and not less than 8 metres in the case of detached and semi-detached dwellings. Where the terraced development consists of the redevelopment into multiple dwellings, the Authority will only allow a façade length of less than 6 metres provided vehicular access to a basement parking area is joint; the amenity requirements of this and other relevant policies are met; and the design and treatment of the façades is such that they do not appear narrow, constrained or inappropriate in their context.*
- Have a developable gross area in line with the provisions of Policy P32.*

In the case of redevelopments, frontages less than 4 metres (terraced developments) or 8 metres (detached and semi-detached dwellings) will be allowed as long as only one unit is created.

P27

DEPTH OF BUILT FOOTPRINT



In order to safeguard the integrity of existing gardens and backyards that provide a positive contribution to the urban grain of a street, neighbourhood or locality in terms of important green enclaves, the depth of the built footprint as measured from the official building alignment will not be allowed to exceed 30 metres, including any basement floors, unless adjacent existing legal buildings on both sides exceed this limit. In the latter case the depth of built footprint will be allowed until the lesser of the two existing depths (Figure 39a).

If the plot lies between an existing legal building that exceeds the 30m-depth and an adjacent site with no building or with a building of less than 30m, it will only be allowed to extend 30 metres as measured from the official building alignment (Figure 39b).

Lesser depths may be required where the building, in the opinion of the Authority, will otherwise compromise the integrity of the green enclaves and/or gardens.

Furthermore:

- *the back elevation context must be taken into account, in line with the provisions in Policy P42;*
- *an element of landscaping within the undeveloped area must be provided, in line with the provisions in Guidance G41.*

The policy will apply both in the case of new developments and redevelopments, the latter also including those developments that currently would exceed the 30-metre depth.

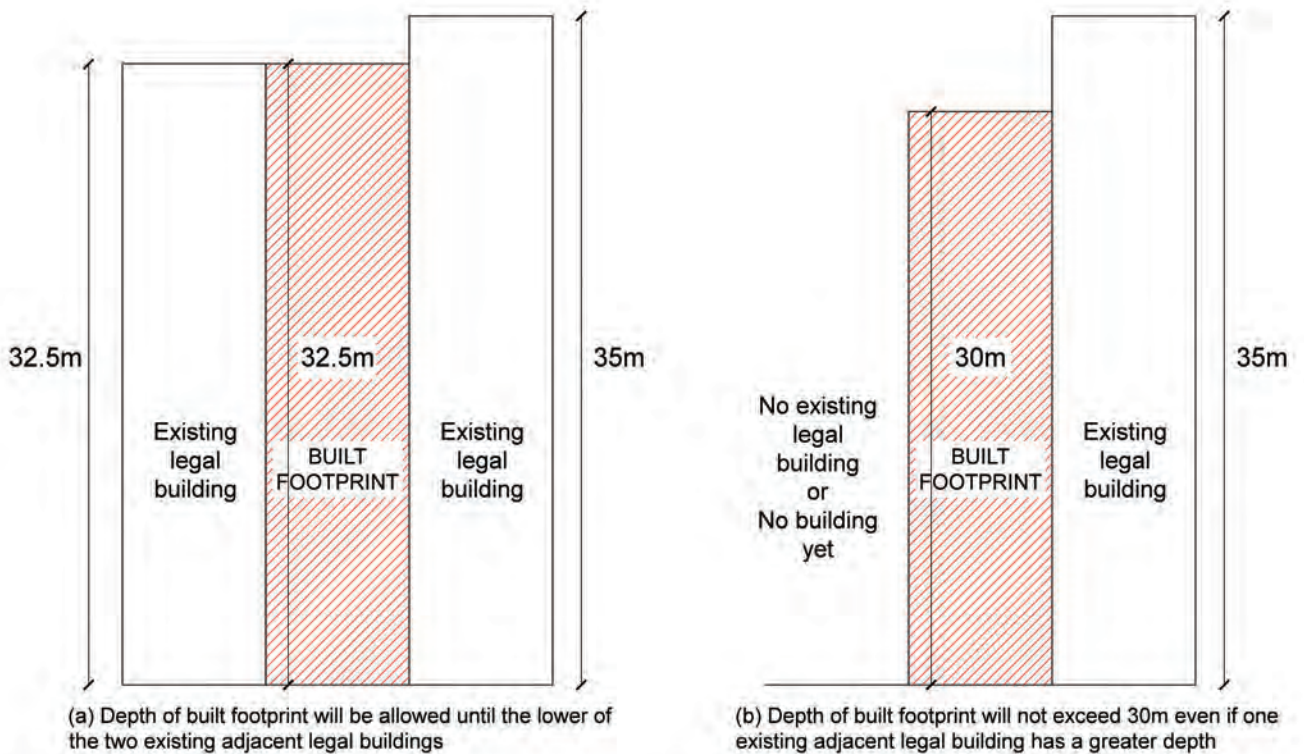

Figure 39: Depth of built footprint (a) with existing adjacent legal buildings on either side and (b) with only one existing legal building

3.1.2 Plot considerations for detached and semi-detached dwellings

Another important factor of urban grain is site coverage, as defined within the Glossary of this document. This becomes a fundamental issue in villa and bungalow areas, wherein the creation and preservation of a degree of spaciousness and detachment contributes towards the character of these areas.

Detached and semi-detached dwellings distinguish themselves from other built typologies due to a number of fundamental characteristics, notable of which are **(Figure 40)**:

- Their contribution to a low-density and low-lying character in villa and bungalow areas, necessitating control in terms of **minimum site area** and **height in metres**, as well as the control of **roof structures**.
- Their relative spaciousness, necessitating control in terms of **site coverage** in order to retain the open space element of villa and bungalow areas.
- Their detached nature, necessitating control in terms of both **site curtilage** (front and side gardens) as well as the presence of fixed or demountable **side structures**, which should not detract from the 'detached' character of the area and so should not physically or visually dominate the side garden.
- Their garden element characterised by **soft landscaping**, in terms of both amount and location.



Figure 40: Well-designed semi-detached dwellings

P28

DETACHED AND SEMI-DETACHED DWELLINGS



Dwellings to be constructed in the areas zoned for detached/semi-detached dwellings in the Local Plans will comply with the requirements for dwelling type, minimum site area, maximum site coverage and minimum side curtilage set out in Table 5 and the following maximum building heights in accordance with the provisions in Policy P35:

- a) Bungalows – 4.75 metres
- b) Villas – 8.5 metres

They are also to have a minimum Gross Floor Area in line with Policy P32.

Any horizontal additions or extensions, particularly when contributing to the site coverage, will adhere to the provisions established in Policy P40.

Locality	Permissible development	Dwelling Type	Min. site area (sqm)	Max. site coverage (%)	Min. side curtilage (m)
Bahar ic-Caghaq	Bungalow	D	1000	30	7.5 (f.g.), 6 (s.c.)
	Villa	D/SD	500	40	3
Iklin	Bungalow	D	750	30	6
	Villa	D	750	40	6
Madliena/ L-Ibragg	Villa	D/SD	500	40	6
Manikata	Villa	D/SD	500	40	3
Marsascula/St. Thomas Bay	Bungalow	D	1000	40	3
	Villa	D/SD	500	40	3
Marsaxlokk	Villa	SD	500	40	3
Mellieha					
(a) High Ridge	Bungalow	SD	1000	40	3
	Villa	SD	500	40	3
(b) High Ridge (facing Santa Marija estate)	Bungalow	D	1000	30	3
(c) Santa Marija, Qortin	Bungalow	D	1000	30	3
	Villa	D/SD	500	40	3
(d) Ta' Halwija	Villa	D/SD	500	40	3
Nadur, Gozo	Villa	SD	500	40	3
Naxxar/San Pawl tat-Targa	Bungalow	D	1000	30	3
	Villa	D/SD	500	40	3
St. Julians	Villa	D/SD	500	40	3
St. Paul's Bay (Tal-Fjuri)	Villa	D/SD	500	40	3
Tarxien	Villa	D/SD	500	40	3
Ta' Xbiex	Villa	D/SD	500	40	3
Xaghra, Gozo	Villa	D/SD	500	40	3
Xlendi, Gozo	Villa	D/SD	500	40	3
Others	Villa	D/SD	500	40	3

Notes:

D = detached; SD = semi-detached; f.g. = front garden; s.c. = side curtilage

Others include:

Attard, Balzan, Bahrija, Bidnija, B'Kara; Bugibba; Gudja; Imriehel; Imsierah; Msida; Kalkara; Kappara; Lija; Mensija; Mosta; Pembroke; Qawra; Rabat (Tal-Virtu); St. Andrews; San Gwann; Sta. Venera; Swieqi; Xemxija

Table 5: Detached and semi-detached dwellings – required standards

The Authority will only consider deviations from the above standards in the case of:

- a) existing smaller villas that are to be redeveloped as single villas;*
- b) existing residual sites that fall below the minimum allowable site area; and*
- c) land subdivision into smaller plots than the minimum plot size specified in Table 5 that has taken place prior to the coming into force of this document for those villa areas where a minimum site area did not apply prior to this document.*

Furthermore, within the localities indicated in Table 5, where the Local Plans do not show a zoning or any zoning conditions, either on vacant sites or on sites where redevelopment is proposed, the height, type and form of development (including dwelling type, minimum site area, maximum site coverage and minimum side curtilage) covered by Table 5 which will be allowed is to be determined having regard to existing commitments, including the previous Schemes for the area and to conditions imposed on permits for sites adjoining the proposed development, in line with the provisions in Guidance G14.



SEMI-DETACHED
VILLAS
SIDE-BY-SIDE

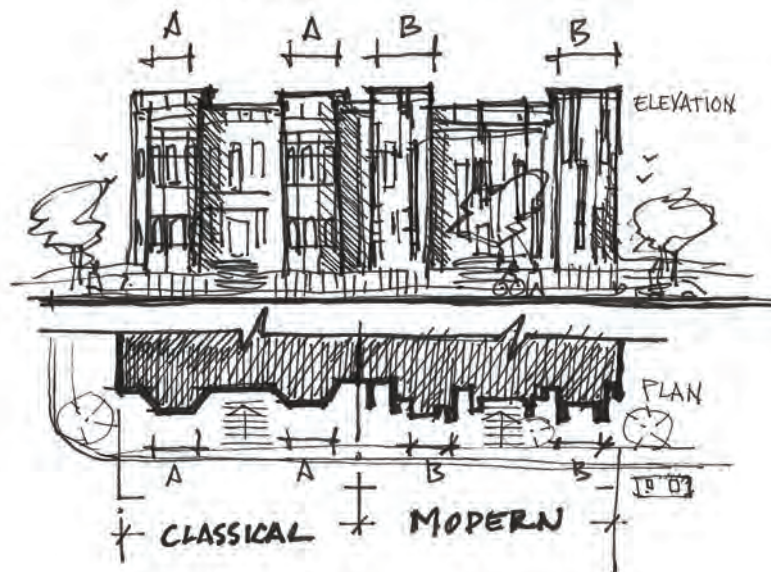

RHYTHM - PROPORTION - TYPOLOGY

Figure 41: Redevelopment of semi-detached dwelling – design considerations

P29

REDEVELOPMENT OF/INTO SEMI-DETACHED DWELLINGS



Where single villa or bungalow plots are allowed to be redeveloped into semi-detached dwellings, as indicated in Table 5, it will be important that the requirements for minimum site area, maximum site coverage and minimum site curtilage are met and the design of the dwellings maintains and enhances the character of the area. Where semi-detached villas are proposed, a block plan will need to be submitted that clearly shows the proposed layout and how the semi-detached units are to be arranged.

From a design point of view, the redeveloped semi-detached dwelling is to respect and follow closely the basic parameters of the adjacent dwelling in terms of urban form – that is, in terms of:

- building line;
- façade proportion;
- building height and massing;
- ground floor treatment and basement levels.

Subsequently, the architectural and elemental design of the redeveloped semi-detached dwelling (in terms of façade projections and setbacks, secondary elements, apertures, materials and colour) will not necessarily be a replica of the adjacent semi-detached dwelling, as long as such design will not detract from the achievement, and appreciation, of the above parameters (Figure 41).

Furthermore, the redevelopment of a semi-detached dwelling into two separate dwelling units will not be allowed.

P30

FULLY-DETACHED MULTIPLE DWELLING COMPLEXES



In areas zoned for villa developments only, the Authority may allow the development of a fully detached complex of multiple units, provided that:

- a) the minimum plot size is 3000sqm;
- b) the site coverage will be in accordance with Table 5;
- c) the minimum Gross Floor Area of each residential unit will be 250 sqm;
- d) there will be no residential units below the ground floor level;
- e) residential units at roof level having a minimum Gross Floor Area of 300sqm per unit will be allowed designed according to the parameters of Policy P39(b);
- f) the design of the dwellings is integrated such that they appear as one coherent building and thus maintain the general character of the area;
- g) the design of the open space that is generated at ground floor by means of this configuration is to remain amenable for common use;
- h) access to the dwellings is internal or by means of an external staircase that will not be visible from the street; and
- i) there will be no garage within the side curtilage.

P31**LANDSCAPING OF DETACHED AND SEMI-DETACHED DWELLINGS**

In *all* detached and semi-detached dwellings, a minimum of 20% of the site area will be provided for soft landscaping, which is to be concentrated within the front and side gardens (side curtilage) of the dwelling in order to exploit the positive contribution such landscaping may provide to the street environment wherein the dwellings are located, in accordance with Guidance G5.

3.1.3 Minimum dwelling areas**P32****MINIMUM DWELLING AREAS AND MIX OF DWELLING SIZES**

In order to guarantee that a reasonable quality of residential amenity and living space standards are provided for the range of different sized residential units, the following minimum Gross Floor Areas, as defined in the Glossary, shall be adopted for all new built housing units located in Area Typologies A1, A2, A3a, A3c, A4a and A4b:

- 55 sqm for a one-bedroom housing unit
- 90 sqm for a two-bedroom housing unit
- 115 sqm for a three-bedroom housing unit

With regard to Area Typology A3b (semi-detached and full-detached villas and bungalows), the minimum Gross Floor Area will be 150 sqm.

In the case of residual developments, the minimum Gross Floor Area will be not less than 55sqm in the case of terraced residential developments and not less than 115sqm in the case of detached and semi-detached dwellings.

In the case of existing committed one-bedroom units, which are less than 55sqm only, the Authority may permit the construction of new one-bedroom units with a similar Gross Floor Area. In no circumstance will the Gross Floor Area be less than 45sqm.

Quality spaces will not only be achieved by adhering to these minimum areas. In tandem with the quantitative considerations, the design of all dwellings is to be guided by the qualitative provisions in Policy P45 and Guidance G24.

In the case of rehabilitated palazzini located within Urban Conservation Areas, while the above areas will be encouraged, the Gross Floor Area for a one-bedroom housing unit may be relaxed to a lower limit of 36 sqm as long as the resultant development will be of high quality and the entire palazzino will function as one complex. The minimum size of two and three bedroom units within the palazzino may be relaxed subject to a good quality habitation space being provided.

Mix of dwelling sizes

In the case of multiple dwellings, the Authority will encourage a mix of dwelling sizes. Such mix is to be dependent on Local Plan provisions and will therefore vary within the different Area Typologies:

- In Area Typologies A1, A3a, A3c and A4a – there will be a maximum of 20% of the development as one-bedroom housing units. Nonetheless, if the site to be developed is restricted in configuration (area and shape), this ratio may be waived.
- In Area Typology A2 – there will be a maximum of 40% of the development as one-bedroom housing units.
- In Area Typology A4b and Student Priority Areas – there will be no maximum capping of the development as one-bedroom housing units.

In the case of Government Social Housing developments, there will be no maximum capping on the mix of dwelling sizes as long as the applicant is an authorised Government entity.

3.1.4 Internal residential developments

P33

INTERNAL RESIDENTIAL DEVELOPMENTS



Only one additional internal residential unit may be allowed subject to provisions in Policy P27, unless a Planning Control (PC) application is submitted whereby new public roads are formed within the proposal, such that all units within the proposed development front such public roads (Figure 42).

Existing internal residential developments

With regard to existing internal residential developments, any changes to such developments will be allowed provided that:

- a) A satisfactory layout and building form can be provided such that adequate outlook is provided for the windows of the main habitable rooms and there is adequate separation between buildings to provide privacy. Specifically:
 - i) where buildings front internal spaces or access ways there will be a minimum 6 metres separation between buildings; and
 - ii) where buildings adjoin the backyards of adjacent buildings there will be at least 3 metres separation.
- b) Where there is an existing party wall adjoining the site, such a party wall will not remain exposed as a blank wall. Any changes to existing internal developments will not give rise to blank party walls that are unlikely to be covered up by developments on adjoining sites. In particular, the height of party walls of any development will not exceed the height limitation for the area.

Furthermore, there will be no subdivision of dwelling units.

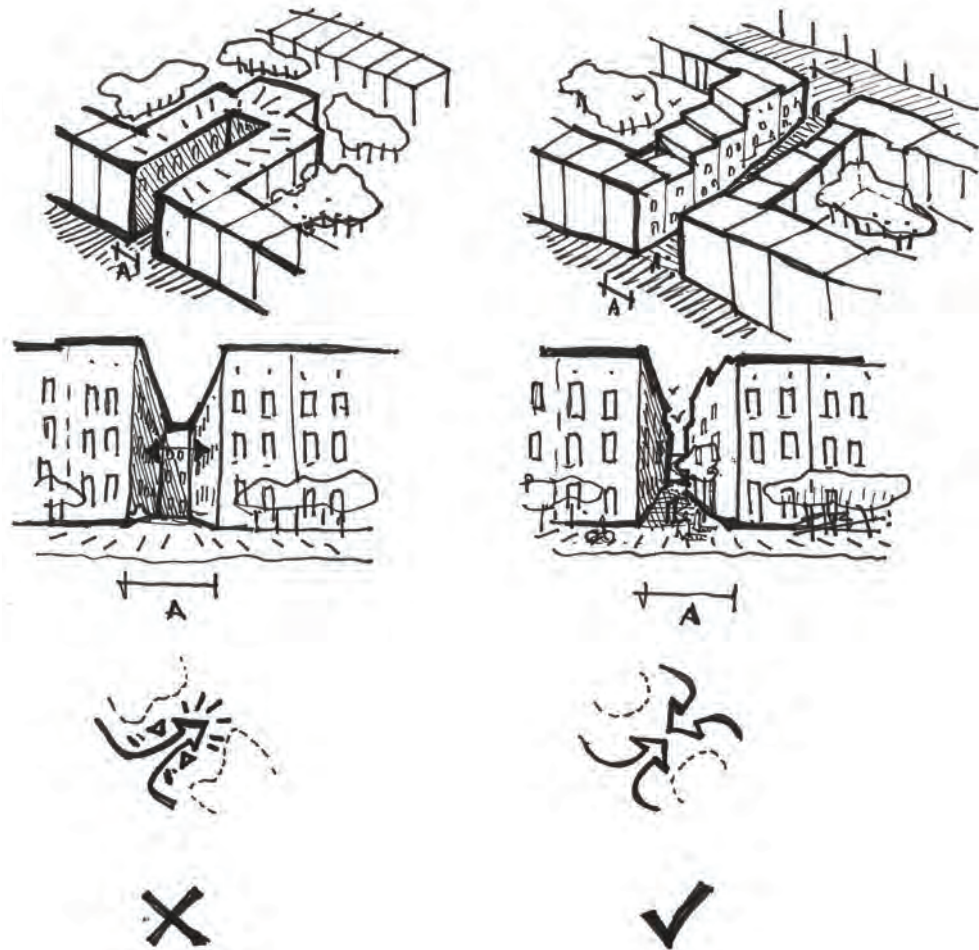

Figure 42: New developments should be seen as an opportunity to increase permeability within urban areas

3.2 SPATIAL ENCLOSURE – BUILDING LINE, FAÇADE PROPORTION AND BUILDING HEIGHT

As discussed in Parts 1 and 2 of this document, the relationship of buildings to spaces is an important component of the townscape and of the quality of urban places, not least due to the spatial enclosure and definition that comes about as a result. Such spatial enclosure is a factor of three important components:

- a) the **building line**, which defines public and private spaces;
- b) the **façade proportions**, which further articulate the enclosure and provide rhythm within the streetscape, particularly in terraced developments; and
- c) the **building height**, which provides the third dimension to the building line and encloses the spaces.

3.2.1 Building line

The building line is one of the most fundamental parameters that define the basic framework for a street. A setback from such building line is therefore generally inappropriate. In the case of detached and semi-detached dwellings, however, such setback would be acceptable given their characteristics discussed in Section 3.1.2 above.

P34

BUILDING LINE



Unless otherwise specified in a Local Plan, the setting back of buildings from the official building alignment will only be allowed in:

- Villa and Bungalow Areas (A3b); and
- Commercial areas (A4b),

where it may be established that such setback will provide a feature of interest and variety that would add to the quality of the streetscape, or in the case of Local Centres (A2) if this will result in the creation of new public spaces, in line with the provisions of Guidance G21.

The appropriate amount of such setback will be determined from the streetscape analysis and street photographic survey, giving regard to issues in relation to both the building proportion and the relationship to the street parameters.

In all other areas, a setback from the building line will not be allowed, in order to maintain and enhance the coherence of the streetscape and the character of the urban townscape. Furthermore, any ramps to basements will not be visible from the street and will be closed off with apertures that are appropriate to the design of the building and to the streetscape in terms of both proportion and materials.

G15

EXPOSED PARTY WALLS DUE TO SETBACK



Where a building is allowed to be set back from the building line, the exposed party wall should be constructed with an additional skin that reproduces the architectural features, materials and details of the front elevation of the protruding building in order to wrap such building around in a continuous manner.

3.2.2 Façade proportion in terraced developments

Terraced developments are characterised by important vertical and horizontal lines that compose the basic façade proportions. Such proportions provide a consistent rhythm within the streetscape, thus contributing to the streetscape's harmony and order, even though the individual façade compositions would differ in terms of the architectural details.

G16

FAÇADE PROPORTION



In order to articulate the spatial enclosure and provide rhythm within the streetscape, the prevailing façade frontage 'x' should first be established from the streetscape analysis and street photographic survey (Figure 43).

The following potential three scenarios may subsequently be envisaged (Figure 44):

- If an infill (terraced) development has a plot frontage that is less than 'x', then an effort should be made to relate to the predominant horizontal lines generated from the neighbouring buildings.
- If an infill (terraced) development also has a plot frontage of 'x', or an exact factor

thereof ('kx'), then such frontage should be integrated and strongly replicated within the proposed development. It should not be essential to relate to the predominant horizontal lines generated from the neighbouring buildings.

If the proposed development relates to the redevelopment of an entire perimeter block wherein it is not necessary to relate to any predominant plot frontage, there should be an effort to introduce innovative design solutions. The developed façades should not appear narrow, constrained or inappropriate in their context, in line with provisions in Policy P26.



Figure 43: Façade rhythm resulting from façade proportions in terraced development

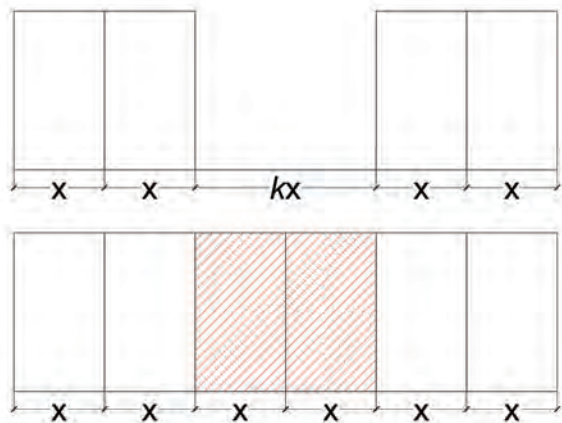

Strong/consistent facade width of 'x' and infill plot width of 'x' or exact factor of 'x', 'kx'

Figure 44: Calculating the correct façade proportion

3.2.3 Building heights

P35

BUILDING HEIGHTS



A building shall not exceed the permissible height as established in the Local Plans, which shall be interpreted according to Annex 2 of this document. Such height shall be measured from the pavement level along the frontage of the building at the highest street level and

will include the provision for any setback floors and services, as well as an obligatory 1-metre parapet wall on the exposed façades at the uppermost roof level (Figure 45). The only vertical structures that may be considered beyond the height limitation will be Wind Turbines (as defined within the Micro Wind Turbines policy), Telephony/Communication Antennae and flagpoles. The height of the street façade is arrived at by deducting 3.4 metres from the maximum allowable height provided in Annex 2.

Within the maximum height limitation, each floor shall have a minimum clear internal height in accordance with Sanitary Law.

Interpretation of building height limitations outside villa/bungalow areas

Where the proposed building has a street façade of at least 12 metres, the uppermost floor above such height will be setback from the street façade. Such setback will be determined using the sight line principle, provided that it is never less than 3 metres. A sight line is to be taken from a point at 1.6 metres height located at the opposite side of the street to the building height along the building alignment, and extended until it meets the maximum height defined in the Local Plans. Figure 46 illustrates the setback for the uppermost floor located above a street façade of 12 metres, 14.1 metres and 21.6 metres, for different street widths. Note that in the case of:

- A street façade of 6.4 metres, where the total height is 9.8 metres – no more than three levels above highest pavement level will be allowed.
- A street façade of 10.1 metres, where the total height is 13.5 metres – no more than four levels above highest pavement level will be allowed.
- A street façade of 14.1 metres, where the total height is 17.5 metres – no more than five levels above highest pavement level will be allowed.

Interpretation of building height limitations for villa/bungalow areas

The height for bungalow and villa developments will be established by offsetting the gradient derived from the site by 4.75 metres in the case of bungalows and 8.5 metres in the case of villas (excluding roof structures, in line with Policy P39), measured from the building line (Figure 47). The existing site levels must be established by the Authority's Land Survey Unit. Particular regard is to be given to the roofs of surrounding buildings in order to tie in as closely as possible with these roofs.

Interpretation of building heights in Urban Conservation Areas

In the case of Urban Conservation Areas, the assessment of building heights on the street façade will be based on the streetscape analysis as established in Policy P4. Additional levels above this height will be assessed on the basis of Policy P39.

When buildings face open areas including piazzas and the countryside or are seafront, a setback of at least 4.25 metres will be required (Figure 48).

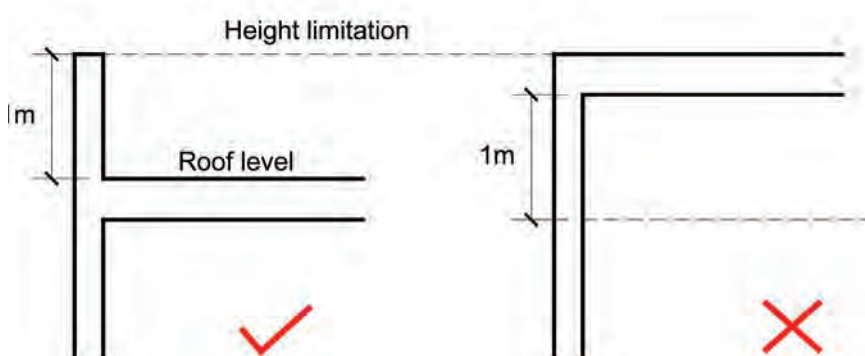
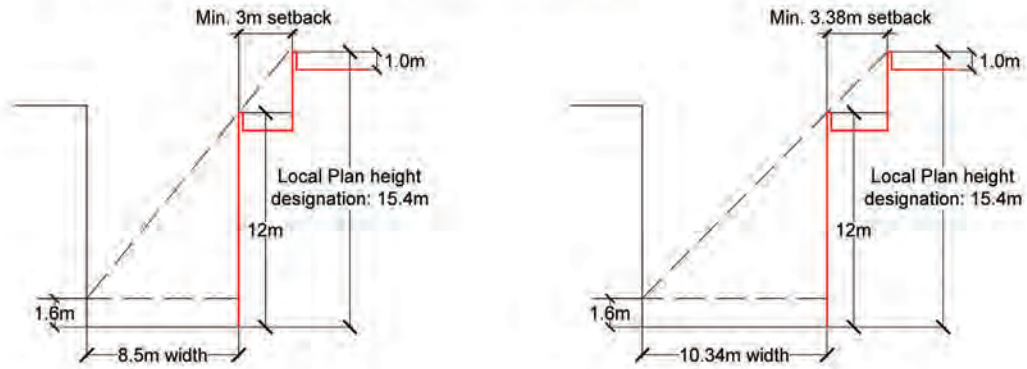
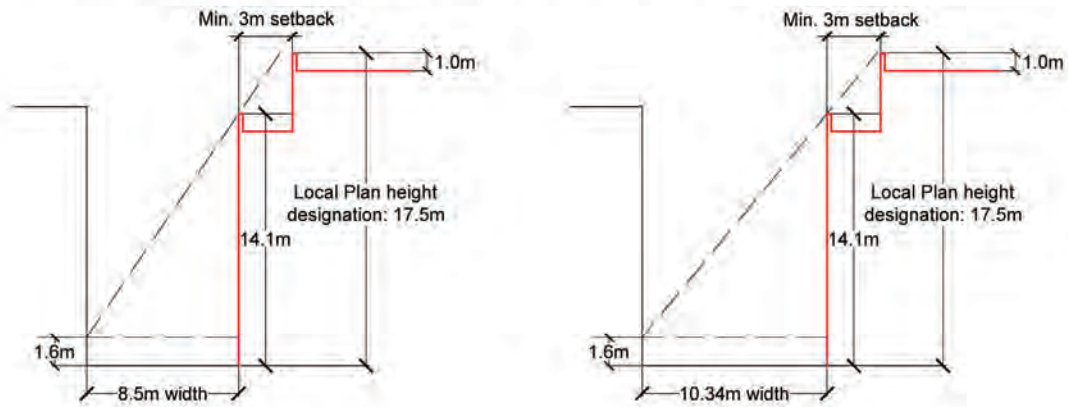

Figure 45: Acceptable (left) and unacceptable (right) design solutions for the 1m roof parapet wall above setback floor

(a) 12m street façade, 15.4m Local Plan height designation



(b) 14.1m street façade, 17.5m Local Plan height designation



(c) 21.6m street façade, 25m Local Plan height designation

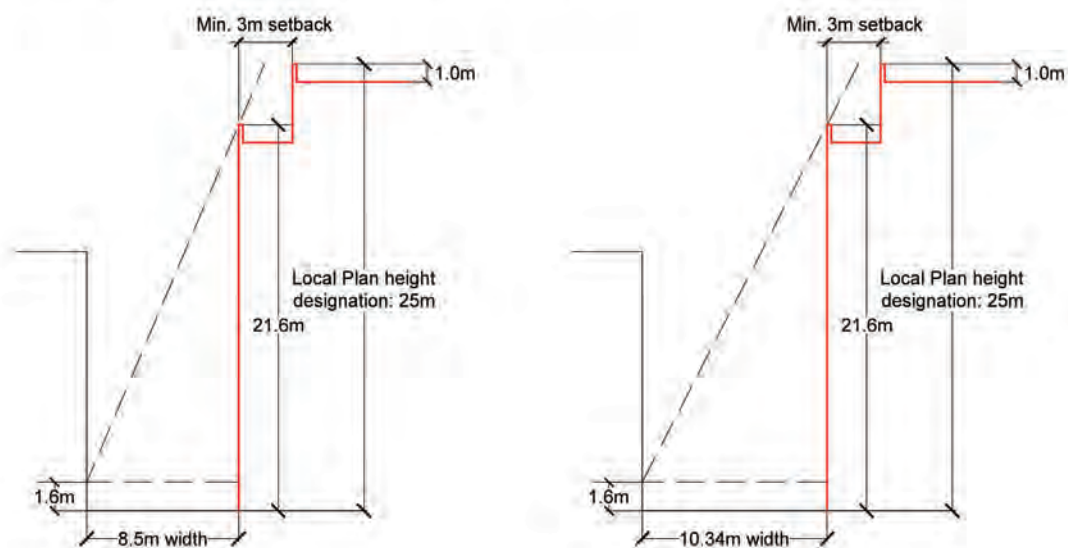

Figure 46: Determination of setback for uppermost floor for a street façade of 12m, 14.1m and 21.6m and a building line-to-building line distance of 8.5m, 10.34m, 13.34m and 16.34m

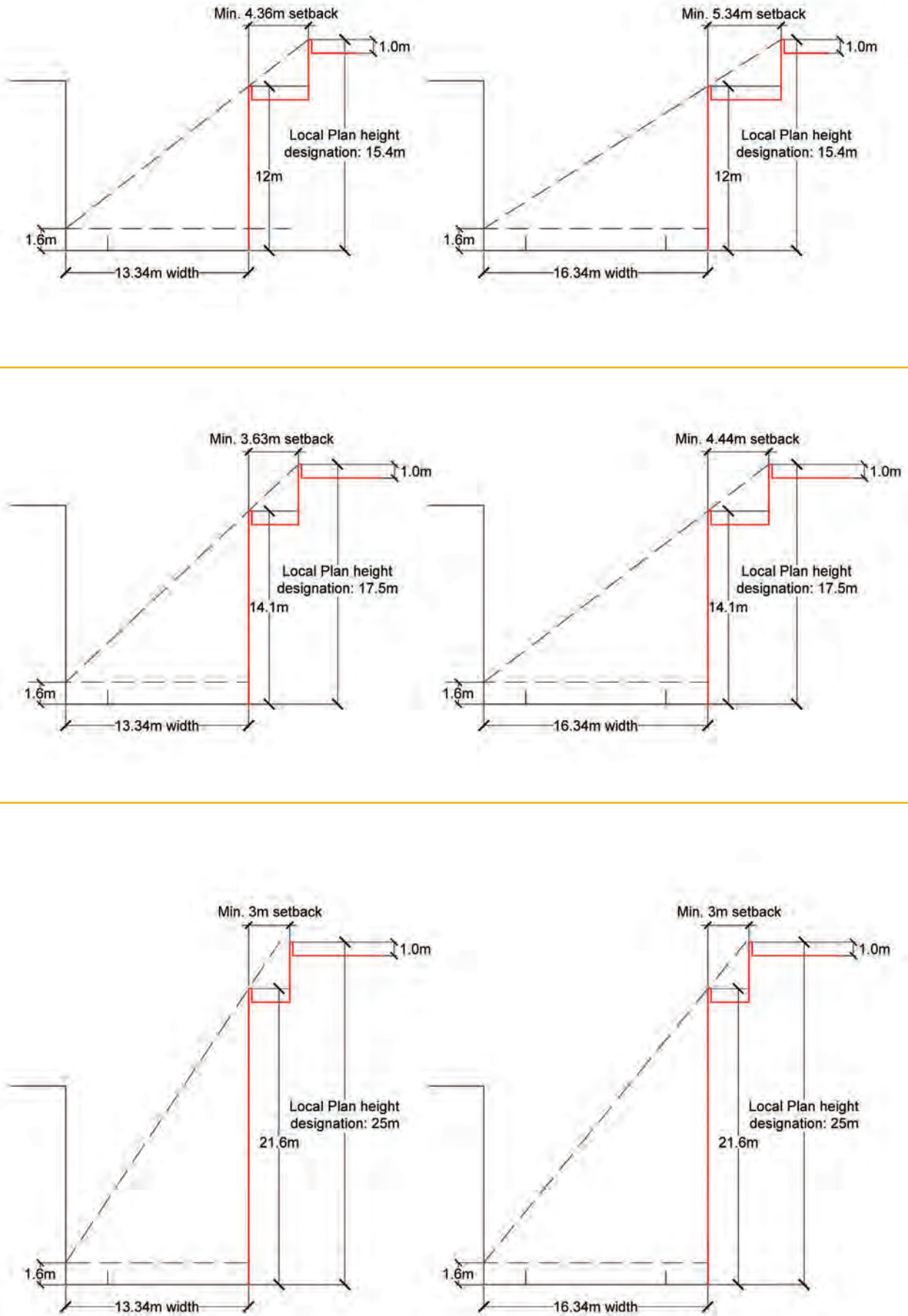

Figure 46 (cont): Determination of setback for uppermost floor for a street façade of 12m, 14.1m and 21.6m and a building line-to-building line distance of 8.5m, 10.34m, 13.34m and 16.34m

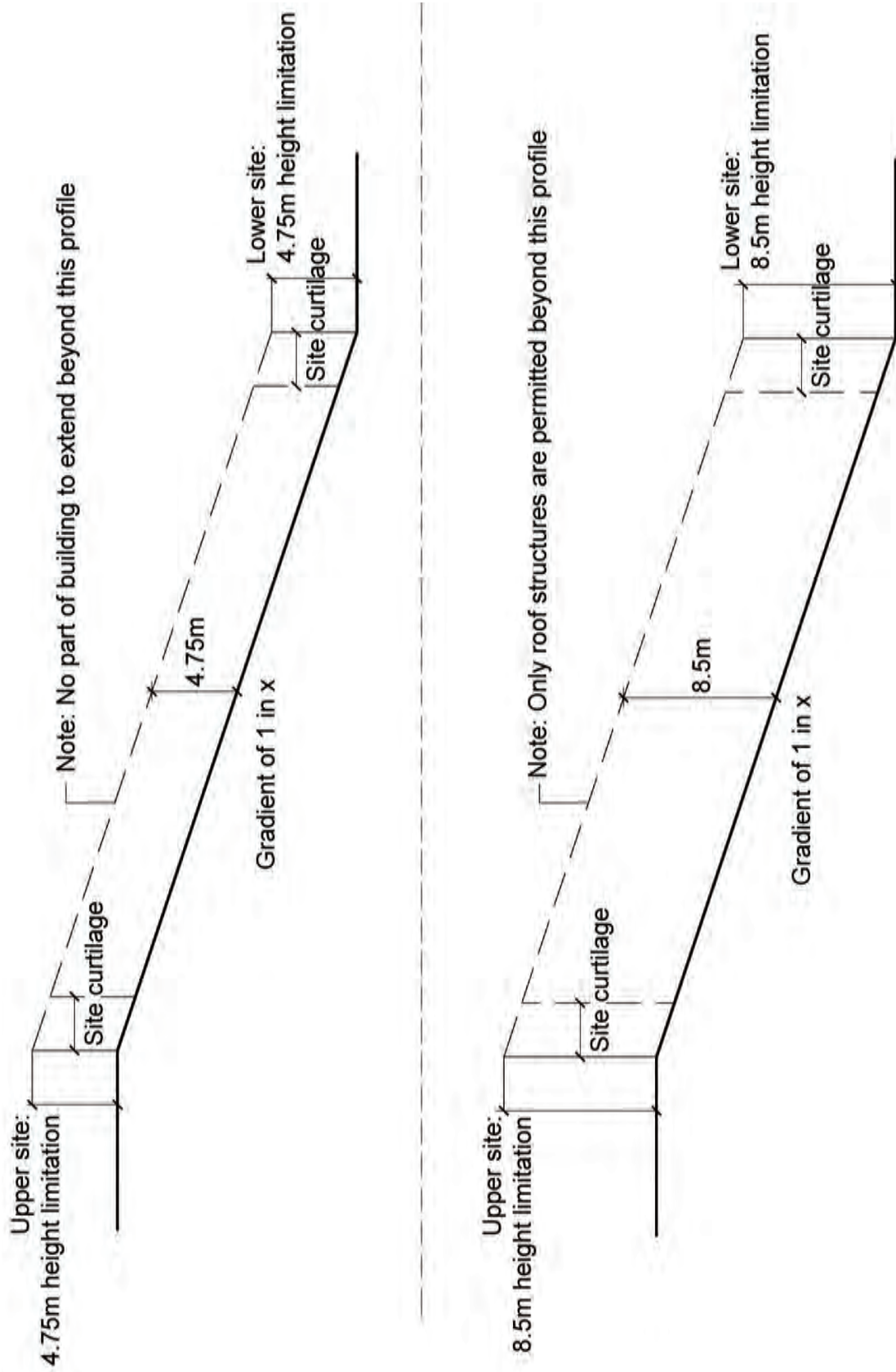

Figure 47: Interpretation of building height limitations for villa/bungalow areas

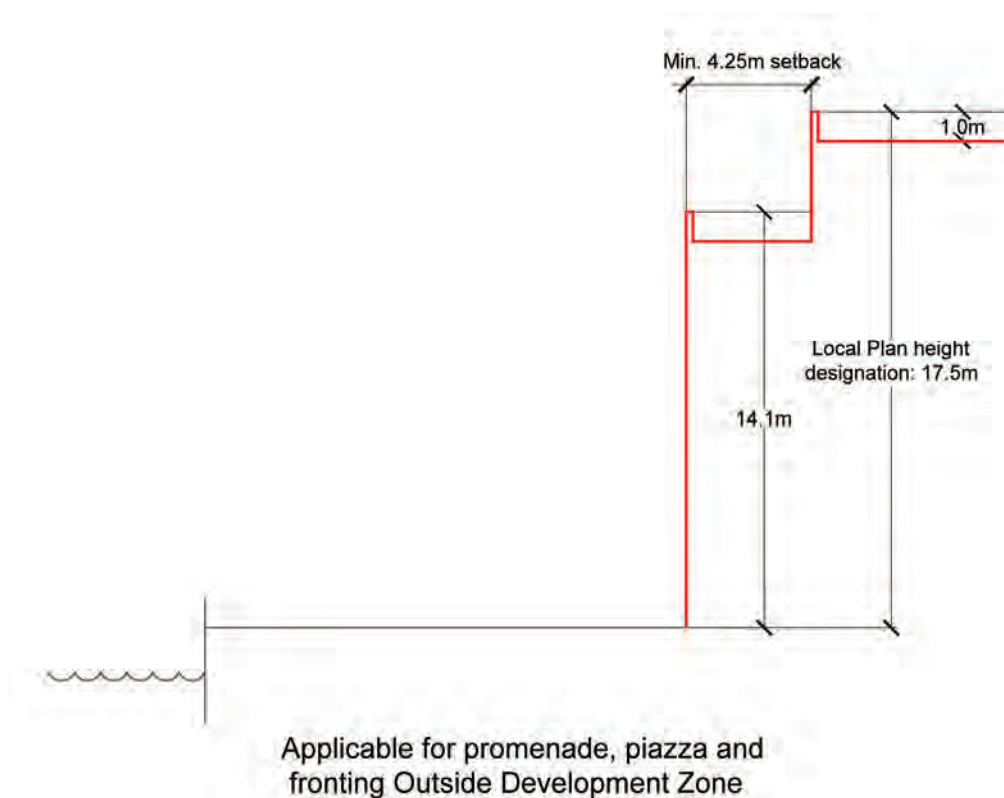

Figure 48: Determination of setback in the case of buildings facing open areas (piazzas and countryside) or for seafront buildings

3.2.4 Building heights along sloping sites or streets

This section builds on the provisions established in Policy P2 and translates the principles therein into design parameters.

P36

BUILDING HEIGHTS ALONG SLOPING SITES OR STREETS



In line with Policy P2, any development or redevelopment located along sloping sites or streets will be bound by the height limitation along the depth of the site and/or along the street. In the case of Urban Conservation Areas, the height limitation is established following the streetscape analysis in line with Policy P35.

The design of such development will furthermore ensure that:

- a) *Its profile and building envelope, including boundary/parapet walls, are compatible with that of buildings on the adjoining plots.*
- b) *It is visually appropriate and will not result in excessive bulk or mass.*

The gradient derived from the sloping site or street levels will first be projected upwards to the height limitation. In the case of two differing height limitations, the projected topography profile will always be projected upwards to the lower height limitation. The building will subsequently be stepped such that at no point along its depth the height

limitation is exceeded, unless compensated by an equivalent area measured along the section of the building and provided that there will never be more than a 3.4 metre-high wall, measured externally. Furthermore, such a building profile will enable the opening of apertures as opposed to generating blank walls. Nonetheless, if blank walls are inevitable, these will be suitably treated with architectural features and/or soft landscaping that complement and enhance the streetscape (Figure 49).

This design approach will similarly characterise developments located within sensitive environmental locations, such as at development edges facing ODZ areas as well as on ridges, the latter in line with provisions established in Policy P3.

In the case of *infill* terraced developments, the scenarios outlined in Guidance G16 should constitute the starting point for any design, with the additional consideration that each step beyond the projected topography profile will not be allowed to exceed 3.4 metres, measured externally, in height (Figure 50).

In line with Policy P2, (a) accurate longitudinal cross sections on at least two positions through the site showing existing site levels (the top soil level) prior to any site clearance or other work; (b) a site survey with spot levels; and (c) proposed site levels will be submitted with the development planning application. Where the site has been excavated for mineral workings or cleared prior to the proposed development, the above height limitations shall be adjusted to the profile of the natural topography extrapolated prior to the excavation. These levels will be checked by the Land Survey Unit.

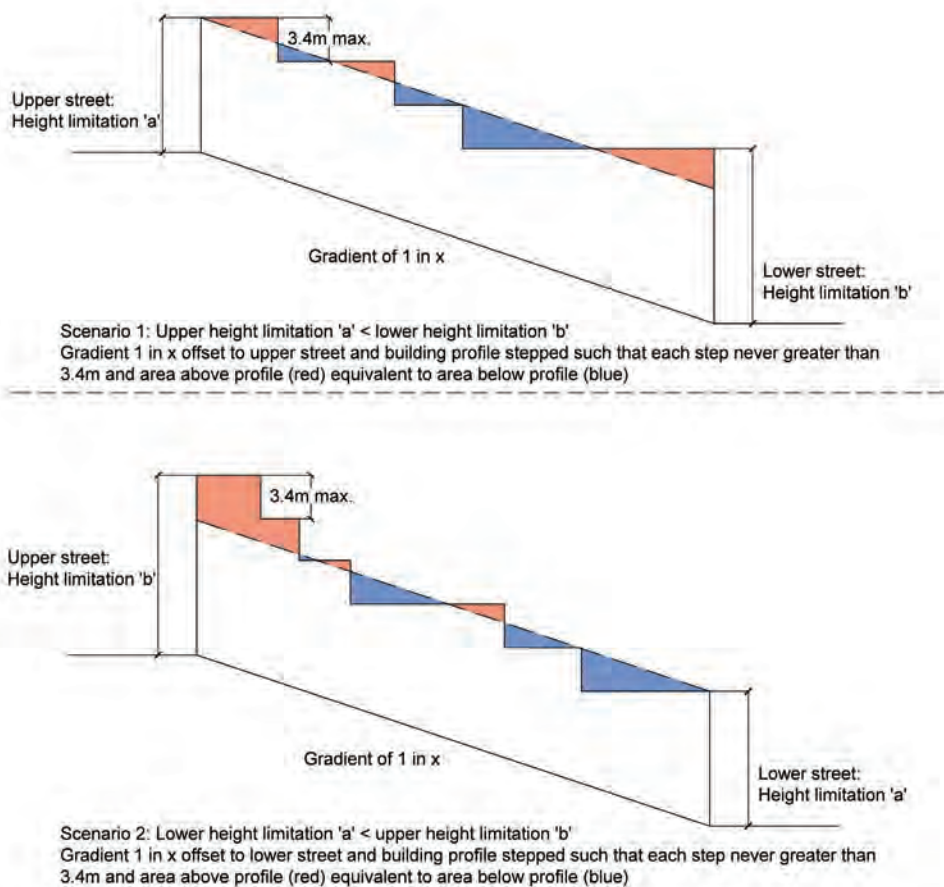
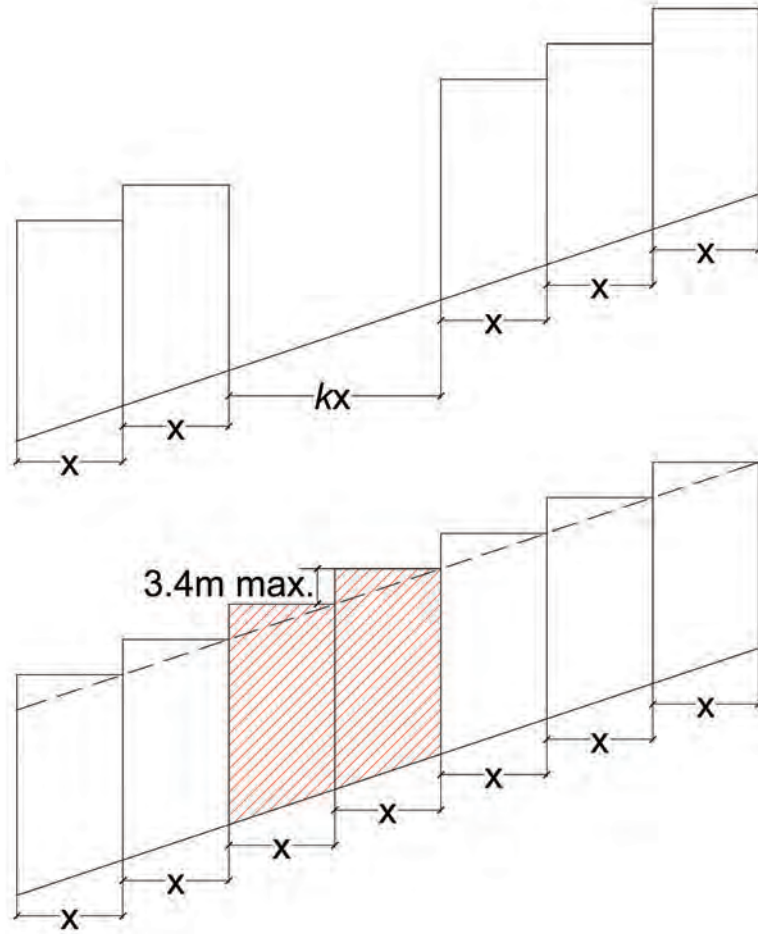

Figure 49: Development of site between two streets located at different levels – except villa and bungalow areas



Strong/consistent facade width of 'x' // infill plot width of 'x' or exact factor of 'x', 'kx'

Figure 50: Development of infill terraced developments located on a sloping street

3.2.5 Building heights on corner sites

G17

BUILDING HEIGHTS ON CORNER SITES



Corner sites offer significant opportunity in terms of visual and architectural gain since they provide legibility to a street and neighbourhood. They also offer scope for releasing public space at important junctions, for instance through the introduction of splays setback further from the building alignment (Figure 51).

In line with the above, and in order to allow for interesting corner schemes to be designed, the Authority may consider an element of flexibility in the way unique building features for developments located on corner sites in some Area Typologies may be developed.

Such development would nonetheless be required to satisfy a number of provisions:

- a) Where there are different height limitations on either side of the corner building, the corner building should still step down in a visually acceptable manner on the higher frontage, and thereby protect the character and amenity of the street with the lower frontage. This is particularly important on narrow urban streets, wherein daylight/sunlight penetration issues become critical.
- b) There should be no generation of blank walls throughout the corner development and the stepping back of upper floors should be accompanied by apertures that open onto terraces.



Figure 51: Corner site designs

3.2.6 Building heights of non-residential developments

P37

BUILDING HEIGHTS OF NON-RESIDENTIAL DEVELOPMENTS



Non-residential developments (either as new constructions or as extended by the addition of extra floors) located in Local Centres (A2), Residential Areas (A3a) and Mixed-Use Areas – predominantly residential (A4a) will not exceed the height limitation in metres of the area in which they are to be located, unless otherwise established within the Local Plans.

As a general principle, the Authority will ensure that non-residential developments do not dominate their surroundings unnecessarily or are detrimental to established landmarks by virtue of their height in those circumstances where it is important to maintain compatibility and continuity with adjoining development.

In order to assess the design implications of non-residential developments, periti will be required to submit photomontages of the proposed development in both the immediate and wider contexts, in agreement with the Authority.

3.2.7 Higher than normal floors

G18

HIGHER THAN NORMAL FLOORS



Higher than normal floors (Figure 52) may be allowed where, in the opinion of the Authority, it would be important to:

- *ensure the compatibility of the proposed development with its immediate context, such as older buildings having higher proportions;*
- *safeguard important horizontal lines along the street façade, in terms of the continuity of floor heights and building elements that contribute to, or form the basis of, the streetscape; and*
- *enhance the overall functionality of the proposed development, particularly in the case of non-residential development.*

The following provisions are to apply:

- a) *The design should be appropriate to the context of the proposed building and to its function and use.*
- b) *Where it is important to ensure that the building is in keeping with the townscape and character of the area in which it is to be sited, the higher than normal floor should be externally designed and perceived as one high floor.*
- c) *The overall height of the building should not exceed the height limitation in metres of the area in which the building is situated.*

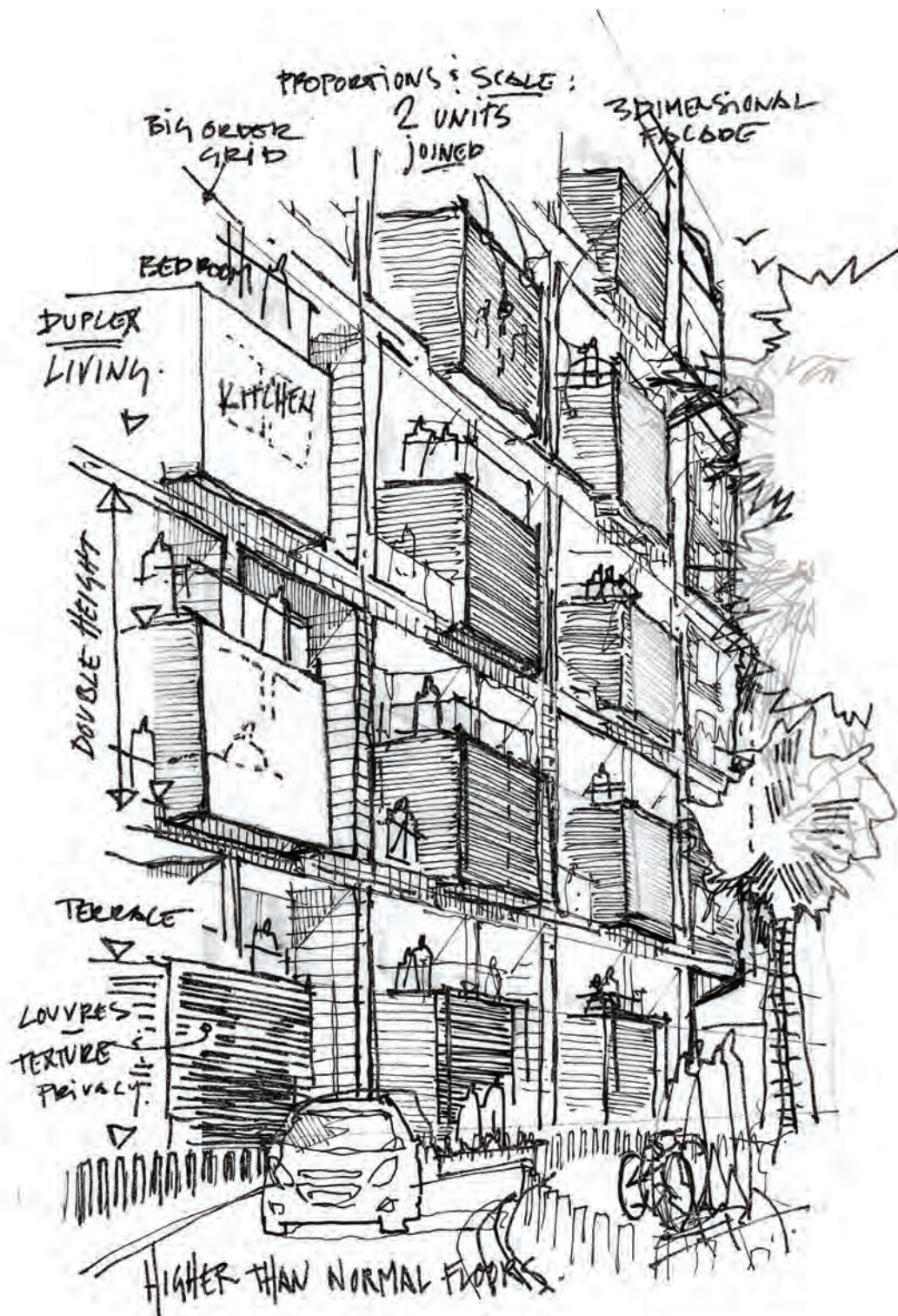

Figure 52: Well-designed development having higher than normal floors

3.3 GROUND FLOOR TREATMENT

3.3.1 Basement levels

P38

BASEMENT LEVELS – DESIGN AND USE



Design of basement levels

Type 1 basements as defined and illustrated in the Glossary (Figure 2) will be allowed in all development scenarios.

Type 2 and Type 3 basements will only be allowed when there are existing commitments for such basements within the perimeter block (as delineated in Figure 18(a)). If such commitments do not exist, only Type 2 basements may be allowed.

Use of basement levels

Separate dwellings that are located at a basement level are considered to be substandard and provide inadequate living areas. For this reason, *in new developments*, no part of the dwelling is to have a separate habitable floor beneath street level (established at the higher street level in the case of a sloping street) for residential purposes.

- a) *In terraced residential developments*, a basement will be designed solely for the purposes of:
- i) parking/garaging of vehicles, where it will comply with the relevant provisions set out in Part 2 (section 2.6) of this document; and
 - ii) commercial purposes, in line with permissible uses within residential areas as defined within the Local Plans, provided that:
 - It has a clear internal height in accordance with Sanitary Law.
 - It can be conveniently and safely accessed particularly for servicing.
 - It shall have adequate fire safety measures.
 - It shall have a toilet for use by staff. A separate toilet for use by customers shall be provided where the proposed unit is a shop which provides a service which requires customers to wait on the premises for that service.
 - It has or will provide adequate natural or mechanical ventilation.
 - It would not have an adverse impact on the amenity of adjoining properties or detract from the amenity of the area in which it is proposed to be located, particularly any overlying dwelling or those immediately adjoining the site, at the sides or rear. Potential impacts to be addressed include noise, disturbance and smell, particularly for food and drink uses, storage and air conditioning or refrigeration.

Preference will be given to the development of a basement for the purposes of parking/garaging of vehicles.

Other basement levels may further be constructed for the purposes of domestic stores and ancillary services. If the above terraced developments contain a front garden, the construction of, or extension to, such basement below the front garden will not be allowed so as to enable the inclusion of landscaping, preferably trees, in line with the provisions of Guidance G5.

- b) *In semi- and fully-detached villas and bungalows; and*
 c) *In residential developments located on edges or ridges,*

a basement will be designed for the purposes of:

- i) *private parking/garaging of private vehicles – where it will comply with the relevant provisions set out in Part 2 (section 2.6) of this document; and/or*
 ii) *domestic purposes (including habitable spaces) – if a level of amenity can be guaranteed, understood in terms of the provision of open space that is immediately accessible and guarantees light and ventilation to the dwelling, as well as – in the case of bedrooms/living rooms – a good level of outlook enjoyed by the dwelling in question.*

Provided that, for both purposes, such basement will:

- *If habitable spaces are included, contain apertures opening onto a terrace space and the open space in question. High-level windows will not be acceptable.*
- *Comply with the basic sanitary conditions and regulations in terms of internal height and proportion of such open space.*

Furthermore, in the case of villas and bungalows, such basement is to be physically and cohesively interconnected in its entirety with the overlying dwelling.

Other basement levels may be further constructed for the purposes of domestic stores and ancillary services. The construction of, or extension to, such basement will however not be allowed beneath the front garden and side curtilage (excluding the back garden), save for the construction of the access ramp to the basement itself. This is being done so as to enable the inclusion of landscaping, specifically the planting of trees, in line with the provisions of Guidance G5.

In the case of (b) and (c) above, particularly when such developments are located on sloping terrain, the broader context in terms of both adjacent developments and developments located above and below the development in question, will need to be analysed in terms of existing basements and will dictate the design accordingly (Figure 53).



Figure 53: Semi-detached villas located on sloping terrain containing a basement level

3.3.2 The design of active ground floor frontages

G19

ACTIVE GROUND FLOOR FRONTAGES



Building frontages should clearly define, and help to differentiate between, public and private space. In designing façades at ground floor, there should be a concerted effort to generate active frontages along the street enclosure.

There are different degrees of active frontage (Figure 54), which may be obtained when the internal uses of a building (as may be applicable): (a) are discernible through the form of the building itself or through appropriate signage or are visible (to a certain extent) from outside the building; (b) invite the passers-by in through clearly legible entrances that are furthermore easily accessible physically; or (c) physically extend out onto such street, as is the case with cafés and outdoor dining areas.

Conversely, there should be an effort to reduce the amount of garage openings onto the street, due to the dead frontages that these openings create together with safety issues in relation to pedestrians. In particular multiple garage openings and access points have an adverse impact on the streetscape and on the character of the surrounding area, giving rise to a loss of amenity.

For this reason, except in industrial areas, there should be no more than three immediately adjoining individual garage openings. In some situations where a site is restricted, such as corner sites, the Authority will carefully consider the proposal and seek to minimise the potential adverse consequences. Apertures and/or other design features should be introduced so as to disrupt arrays of garages/vehicular accesses in order to increase road safety (including pedestrians) and enhance the streetscape.



Figure 54: Well-designed active frontages

3.4 SETBACK FLOORS AND HORIZONTAL ADDITIONS

G20

SETBACK FLOORS AND HORIZONTAL ADDITIONS



Setback floors and horizontal additions within side gardens should be considered in relation to the following guiding principles:

- They should be appropriate to the architectural design sought within the rest of the building, especially if such building is existing – in terms of built form proportions, materials and details, although this does not necessarily imply copying such design considerations.
- They should not unduly affect the amenities of neighbouring properties in terms of daylight, outlook and overlooking.
- They should not exceed the height in metres of the area within which the building is located, as established within the Local Plans.
- They should comply with the other policies set out in this document.

In all situations, the effect of such additions, extensions and alterations on the amenity of adjoining properties should be considered, and every effort made to minimise any potential adverse impacts.

3.4.1 Setback floors

P39

SETBACK FLOORS



Setback floors, which may include roof structures, will be allowed provided that:

- The design and materials used will be compatible with the remainder of the building and with the general character of the area, including the streetscape and the skyline.
- The setback floor will not intrude into important long-range or short-range views, particularly those defined in Local Plans, nor obscure important landmark buildings from view.
- No services or additional structures will be allowed beyond the maximum height limitation (Figure 55). PV panels, where required, will have to be incorporated within the design of the roof of such structure, in line with the provisions set out in Guidance G26.
- Only awnings will be allowed as additional elements attached to the front and back façades of the setback floor.

In the case of setback floors outside Urban Conservation Areas:

- The overall height of the building, including such setback floors, will not exceed the overall permissible height of the building as set out in the Local Plans.
- The setback floor will be set back in line with the provisions in Policy P35.
- In the case of properties having a street façade height up to 10.5 metres, a roof structure only, not exceeding 36 square metres and an overall height of 3.4 metres measured externally, will be permitted having a setback in line with the provisions in Policy P35. No roof services or additional structures will be permitted beyond this height.

In the case of setback floors within Urban Conservation Areas:

- The setback from the façade must never be less than that of the committed adjacent properties on one or both sides, where applicable. If such commitments do not exist, no setback floor will be allowed. In the case of corner sites, it must be ensured that setback floors do not create an unacceptable visual impact. The sight line principle established in Figure 46 may similarly be applied for such corner sites. In all cases, the massing of the setback floors should visually relate to that of the adjacent properties.

With regard to roof structures on detached and semi-detached dwellings:

- a) No roof structures will be allowed on the roofs of bungalow developments located in Residential Priority Areas. Access to the roof of the bungalow will occur through an external staircase located within the side curtilage of the dwelling, in line with the provisions in Guidance G34.
- b) Roof structures for semi-detached or detached villas will be permitted beyond the building envelope as indicated within Policy P35 (Figure 47) and with a maximum floor area of 25% of the built footprint. In all cases roof structures will be integrated and designed as one structure and will not exceed a height of 3.4 metres measured externally. No roof services or additional structures will be permitted beyond this height.

This policy also applies in the case of stairwells within existing developments, which setback less than that resulting from the application of Policy P35.

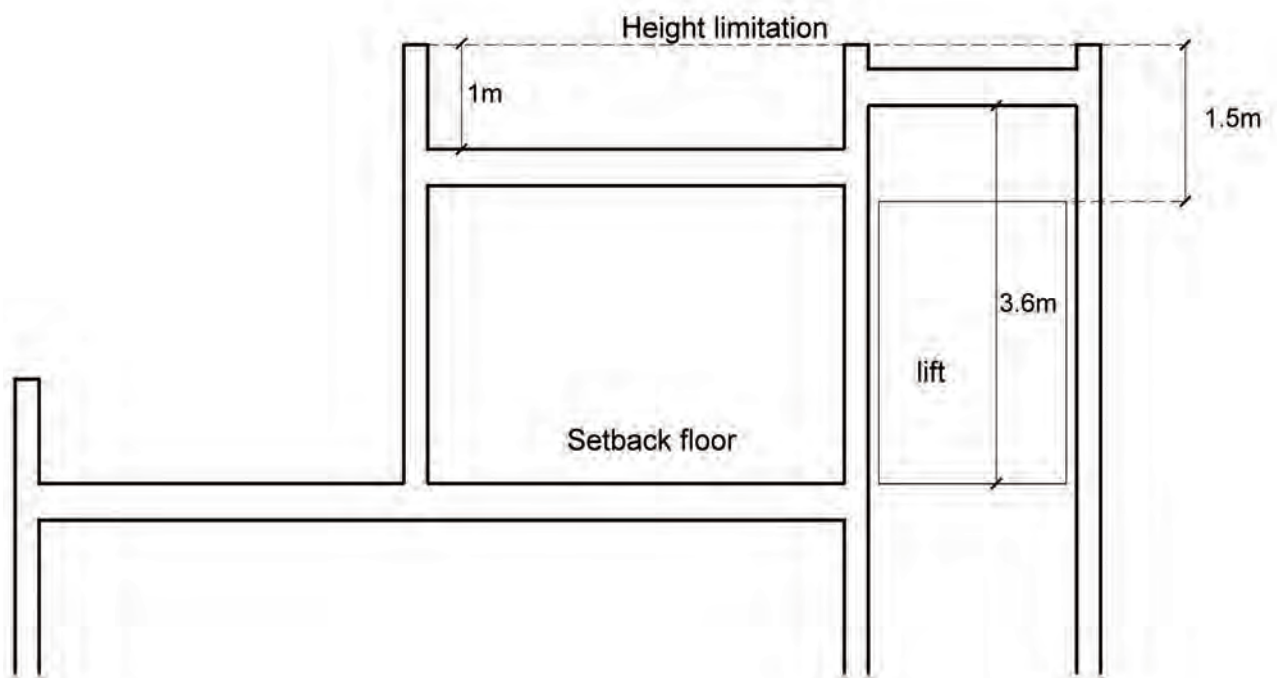

Figure 55: Setback floor being served by lift – design considerations

3.4.2 Horizontal additions within side gardens – part of the dwelling or extensions

P40

HORIZONTAL ADDITIONS WITHIN SIDE GARDENS



In those localities where a 6-metre side curtilage is allowed:

- part of the building may be erected within such side curtilage; and
- the construction of an extension within such side curtilage will be allowed,

provided that (Figure 56):

- a) The area of the building constructed within the side curtilage is compensated for by an equal area receded from the side curtilage on the same side of the plot. In no case will this be allowed to exceed half the length of the side elevation.
- b) The building or extension will not be closer than 4.5 metres to the site boundary.
- c) The building or extension must be setback by a minimum distance of 4.8 metres from the building line.
- d) The design of the building or extension will ensure that the amenity of the neighbourhood property, particularly with regard to privacy, is not jeopardised. To this effect, (i) no balconies will be allowed within this part of the building; (ii) doors will only be allowed at the lowest level; and (iii) only high-level windows will be allowed.
- e) The design of the building or extension will provide visual interest, within and outside the garden area.

It will also be permissible to construct:

- a) Free standing gates and building elements (e.g. arches), provided that (i) they do not project beyond the building alignment; (ii) they maintain the open character of the area; (iii) they are not to exceed a height of 2.7 metres above ground level; and (iv) they are to have an opening width of at least 2 metres.
- b) A carport, in line with the provisions of Policy P9, provided that there is no garage.
- c) A garage, in line with the provisions of Policy P22.

In the case where a 3-metre side curtilage is present, it will only be allowed to construct:

- a) free standing gates and building elements (e.g. arches);
- b) a carport or garage,

in line with the provisions outlined above.

It will not be allowed to construct any of the above structures within the front garden.

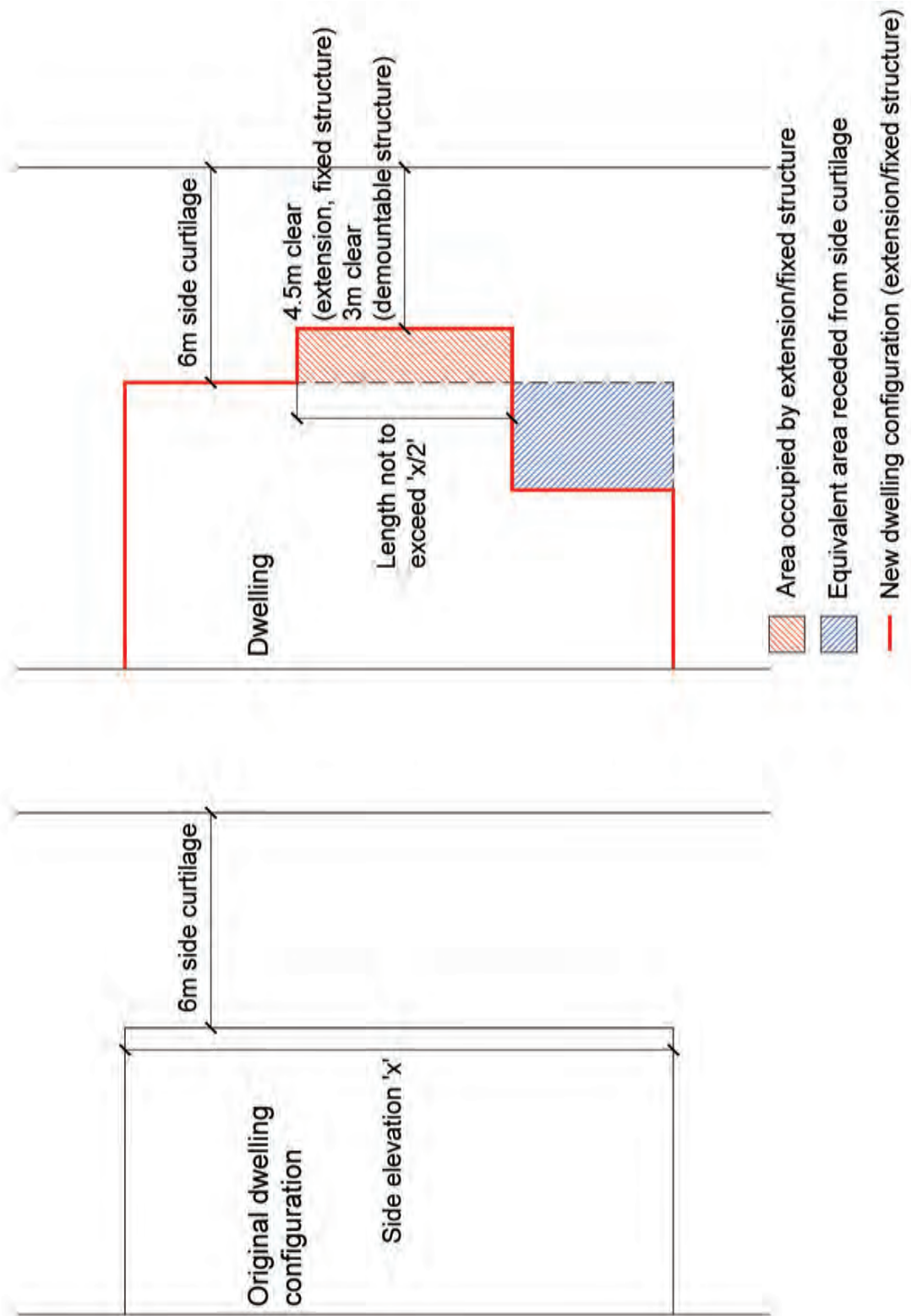

Figure 56: Horizontal additions within side gardens – key design parameters

3.5 URBAN FORM – QUALITY CHECKLIST FOR *PERITI*, ASSESSORS AND DECISION-MAKERS

Urban grain and built form

- Has the existing urban grain been taken into account at the onset of the design process and have specific urban patterns developed that merit retention within the proposed development?
- Does the design reflect the positive characteristics of built form (building layout, form, scale, style, plot size, density, setbacks and boundaries, etc.?)
- Will the development be seen from close, medium or long range, and does this affect overall height, profile and degree of detail?
- Have both the quantitative and qualitative considerations been taken into account in the schematics of plot sizes and plot considerations for detached and semi-detached dwellings and is there a good balance of built and unbuilt space?
- Specifically, does the detached and/or semi-detached dwelling follow quantitative provisions in terms of site area, height, coverage, curtilage and amount of landscaping? Does the detached and/or semi-detached dwelling follow qualitative provisions in terms of its design, detached nature and quality/location of soft landscaping?
- In the case of redevelopment of/into semi-detached dwellings, have the appropriate design considerations been taken such that the two dwellings relate well to one another with regard to key urban form parameters?
- Does the development provide adequate dwelling space in terms of respecting the minimum gross floor areas?

Spatial enclosure

- Does the development offer adequate spatial enclosure?
- Is the building line respected and does it follow coherently with the adjacent buildings? Does the frontage relate well to the overall existing context?
- If there has been an intentional deviation from the building line, is the space generated in front of the building well defined, and does it have positive urban design qualities?
- Have the façade proportions been worked out properly in a manner that does not create narrow and constrained façades?
- Can a consistent façade rhythm be established through a prevailing plot frontage and is it desirable to replicate this frontage?
- Does the development adhere to the height limitation that is set within the Local Plans and interpreted according to Annex 2 of this document?
- Is there a good balance in terms of the size of the space (and the width of the street) and the height of the development that encloses it?
- Does the building profile respect the streetscape and human proportion, and are the setbacks provided adequate?
- Does the new development respect clear existing commitments along the stretch of perimeter block fronting the street having a lower building height than that stipulated within the Local Plans?
- In the case of sloping sites or streets, does the building step adequately along the established gradient and does it fit seamlessly within the profile?
- In the case of corner buildings and non-residential developments, have deviations been made to the building profile and, if so, do they contribute positively to the broader setting in terms of providing new landmark buildings?
- Do the higher than normal floors offer a positive contribution to the streetscape and aid in the building's legibility and relationship with the human scale?

Ground floor treatment

- Have the provisions for basements been adequately dealt with and, where proposed for residential (habitable) purposes, is the proposed environment amenable enough to justify it?
- Does the development make a positive contribution to the street, in terms of providing new active frontages?

Setback floors and horizontal additions

- Do the proposed setback floors fit within a good building profile that takes into account the relationship with the street and humans?
- Have both the quantitative and qualitative considerations for setback floors in relation to the rest of the building been taken into account?
- Specifically, has the height limitation been respected?
- Do the setback floors and/or horizontal additions complement the original building in terms of scale, design, form and finish?
- Specifically, is the location of the setback floor and/or horizontal addition appropriate with regard to the main building and the rest of the street?
- Has the potential impact to neighbouring properties generated by the setback floor and/or horizontal addition been adequately addressed in design terms?





04

ARCHITECTURAL QUALITY

- 4.1** NEIGHBOURHOOD AMENITY
- 4.2** EXTERNAL APPEARANCE
- 4.3** DEVELOPMENT AMENITY AND SUSTAINABLE QUALITY
- 4.4** THE DESIGN OF PUBLIC BUILDINGS AND NON-RESIDENTIAL DEVELOPMENTS
- 4.5** THE DESIGN OF SHOP FRONTS
- 4.6** ARCHITECTURAL QUALITY – QUALITY CHECKLIST FOR PERITI, ASSESSORS AND DECISION-MAKERS

04

ARCHITECTURAL QUALITY

Having established the contextual considerations that are to be taken on board at the onset of any design and development process (Part 2), followed by the key determinants in relation to urban form (Part 3), Part 4 outlines the main components in relation to Architectural quality (**Figure 57**).

In the discussion of what constitutes architectural quality, careful attention has been paid to the potential pitfalls of architectural subjectivity. For this reason, most of the provisions in this Part are good-practice guidance, in the knowledge that there might be more than one architectural solution to achieve the general intent being expressed in the individual sections. Furthermore, there is no discussion about issues in relation to architectural style, in recognition of the fact that this aspect is intrinsically tied to the specific context and that *both* traditional and contemporary architectural styles may be innovative and contextual and may complement, and indeed enrich, the existing townscape.

The onus of this Part is therefore the 'quality' component of architectural design, which necessitates any *perit* and assessor to acknowledge issues with regard to neighbourhood amenity (Section 4.1), particularly with regard to issues of safety and privacy; external appearance (Section 4.2), including spatial interfaces and issues in relation to visual interest, side and back elevations, projections and setbacks; development and internal amenity and sustainable quality (Section 4.3), with a focus on the integration of active and passive energy systems and microclimatic considerations; the design of public buildings and non-residential developments (Section 4.4); and the design of shop fronts (Section 4.5).

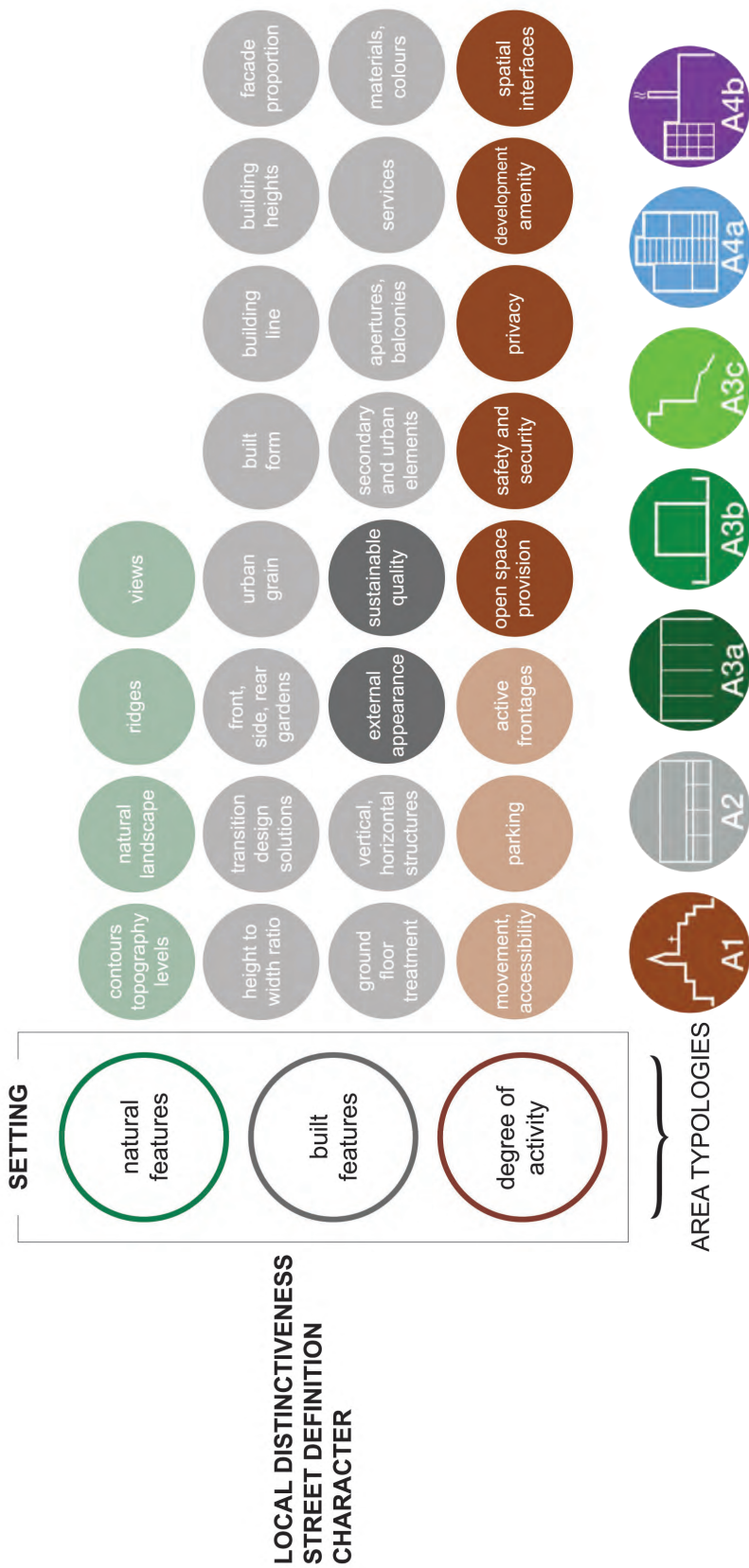

Figure 57: Contributors to setting, local distinctiveness and streetscape – the remit of Part 4 is highlighted

4.1 NEIGHBOURHOOD AMENITY

4.1.1 Creation of, and access to, open spaces

G21

CREATION OF, AND ACCESS TO, OPEN SPACES



All developments should aim to provide a positive spatial contribution to their context in the definition, and enclosure of existing spaces.

In a number of urban areas, but particularly within Urban Conservation Areas, gardens and backyards characterise the traditional built configuration of introvert open space. In these areas, public and private open spaces perform a number of important functions:

- a) *Open space provides separation and distance between adjacent land uses in often high-density areas. This helps to protect amenity (for instance, by suppressing noise) and provides fresh air and light, doubling up as green enclaves, or green lungs.*
- b) *The protection of open space helps support farmland, trees, vegetation and other traditional urban activities.*
- c) *The relationship between built and unbuilt land defines the form of the urban settlement and is a fundamental organising force in defining the sense of place.*
- d) *The hierarchy of open spaces establishes the relationship between public, semi-public and private areas, in line with the provisions in Guidance G22.*

The development of gardens and backyards therefore leads to the loss of such valuable amenity space and should be resisted, particularly within UCAs.

Rather, the generation of new public or semi-public open spaces within the urban fabric should be encouraged, so as to:

- *increase the quality, amenity and attractiveness of both the development itself and the broader context; and*
- *contribute to a potential open space network, which furthermore provides new and/or improved links that increase the permeability and accessibility of the urban fabric, in line with the provisions in Guidance G6.*

Such open spaces may be formal, such as a new public piazza, or informal, like a hard or soft landscaped semi-public recreational space (Figure 58), in line with the provisions in Guidance G41. Access to such amenity space can make an important contribution to the overall quality of the urban environment (be it residential, non-residential or mixed-use). To this effect, the Authority will encourage developments to create new open spaces, including public amenity space, which should be suitably linked to the developments' surrounding, be designed with adequate materials that are well-detailed (in line with Guidance G51) and function well with regard to microclimatic considerations. The use of such space for car parking will be discouraged.

Particularly where there is no existing reasonable open space provision within walking distance of the site and safe access to it from the site, however, the provision of new on-site open amenity space/s may be specifically demanded by the Authority. The size of such space/s is to be calculated at a reasonable ratio per dwelling that takes into account individuals' recreational and activity requirements. Continuing protection and maintenance of such space will be secured by development control conditions.

Notwithstanding the above, the Authority may, where it considers it more appropriate having regard to the shape/configuration and location of the site and the nature and availability of land for existing, allocated or schemed open space/s in the area, require the payment of a financial contribution towards the creation, improvement and/or upkeep of such open space/s located within walking distance of the site. In determining whether to require on-site provision or a contribution to off-site open space the Authority will have regard to the current level of open space provision in the vicinity of the site and in the local council area within which the site is situated.



Figure 58: *Well-designed open spaces provide an important asset to urban environments*

4.1.2 Safety and security, design of spatial interfaces

G22

SAFETY AND SECURITY, SPATIAL INTERFACES



Any new developments or redevelopments, including both the built and unbuilt fabric, should be designed in such a way as to help create a safe and secure environment and to reduce the opportunities for crime. In this respect there should be a clear distinction between public and private spaces in order to:

- *provide for secure private or semi-private areas and guarantee their privacy; and*
- *allow for the natural surveillance of public areas.*

The architectural treatment of spatial interfaces should therefore provide different degrees of visual and physical permeability in accordance with the different spatial typologies that are being defined and enclosed – public, semi-public, semi-private, or private.

In this respect, dead frontages are to be avoided (in line with the provisions in Guidance G19), entrances and exits are to be carefully designed and any allowed setback from the building line (in line with the provisions in Policy P34) should create safe and secure public spaces that have:

- a) clear boundaries;*
- b) carefully-designed landscaping, in line with the provisions in Guidance G41, that avoids potential hiding places; and*
- c) suitable lighting design that avoids the formation of dark spots and aids users' orientation and navigability.*

4.1.3 Privacy between buildings

Besides allowing for a good outlook of outdoor space, in line with the previous guidance, any development should also maintain and enhance internal privacy. This is particularly critical with regard to the spacing of buildings. This policy is an interim policy pending the approval of the Building Regulations.

P41

PRIVACY BETWEEN BUILDINGS



All new built residential development, particularly where such development is proposed on narrow pedestrian/vehicular accesses, will provide a reasonable standard of visual and aural privacy, through:

- a) horizontal distance separation;*
- b) changes in level;*
- c) internal layout;*
- d) aperture design (size, shape and position) and screening; or through a combination of these measures.*

No window or balcony will overlook the aperture of a habitable room of another dwelling, except where the distance is equal to, or greater than, the distance specified in Standard S7 or where privacy may be ensured by aperture design or the provision of screening. In the

case when the distance is *less* than that specified in Standard S7, provision is to be made for the staggering of apertures such that they will not be directly opposite one another, if the plan configuration and façade proportions permit (Figure 59c).

The apertures of new non-residential development, especially offices or other buildings which people are likely to occupy for considerable periods of time, is to maintain the privacy of adjacent residential development, through the application of the minimum separation distance and/or through window design or the provision of screening.

This policy is not directed at the maintenance of privacy between units within a building which may be grouped around internal spaces, such as an internal yard.

S7

PRIVACY STANDARDS



In new large-scale and comprehensive developments, there will be a minimum separation of 6 metres between the main apertures of habitable rooms, where these directly overlook another dwelling (Figure 59a,b).

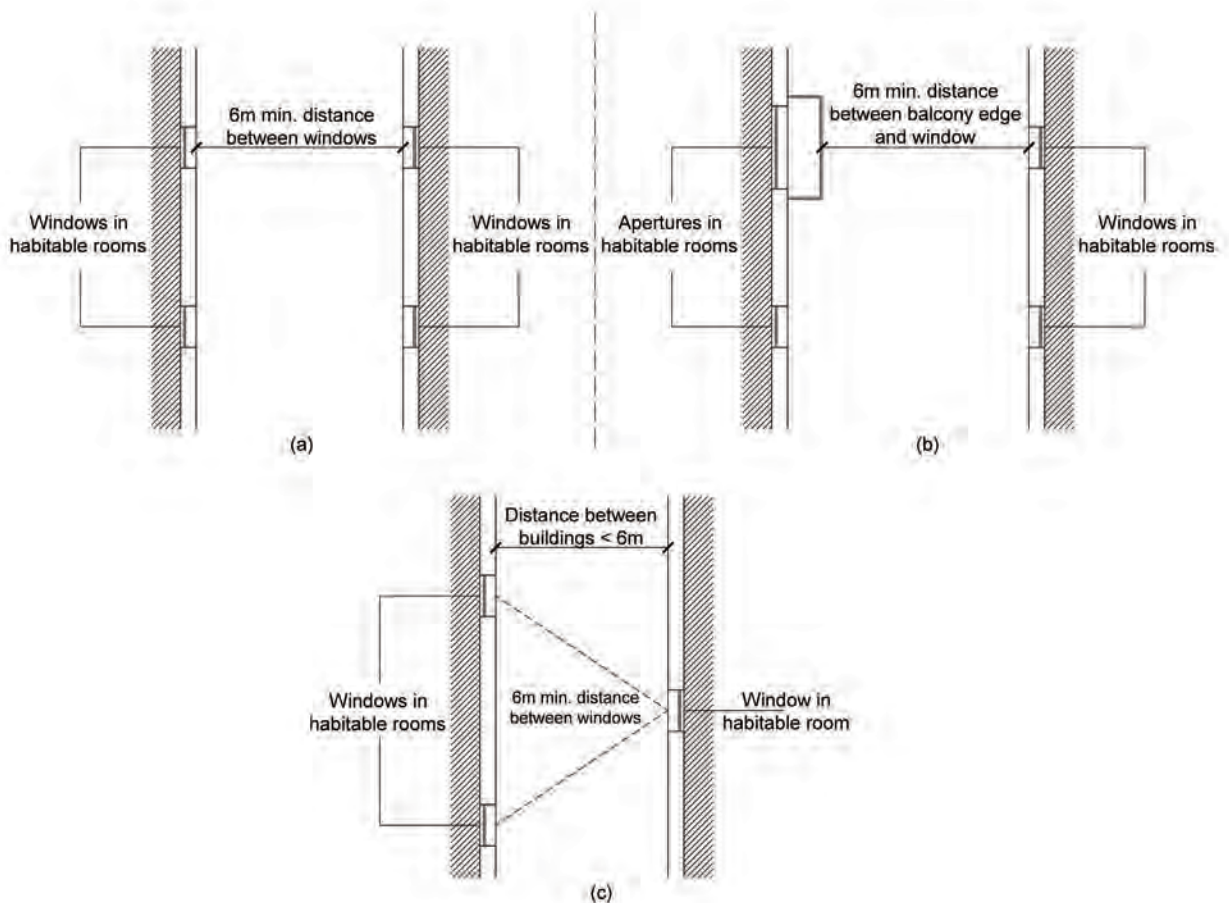

Figure 59: Privacy standards

4.2 EXTERNAL APPEARANCE

4.2.1 Visual interest

G23

VISUAL INTEREST



The external design of all new developments should seek to provide visual interest, enriching the quality of the context within which they are located. Such interest may be derived from both volumetric/massing (articulation through projections and/or setbacks in accordance with the provisions in Policies P43 and P44) and elevational treatment (including architectural elements, in accordance with the provisions in Part 5 of this document) of the buildings, contributing to a positive visual aspect in the short-, medium- and long-range.

In Local Centres (A2), Villa and Bungalow Areas (A3b), Mixed-Use Areas – Predominantly residential (A4a) and Commercial areas (A4b), so as to encourage a high quality of architectural and urban design, the Authority may allow projections, setbacks and other articulation of the building façades (front façades, side façades of detached and semi-detached developments and back façades if visually prominent), which would otherwise not comply with the provisions in Policies P43 and P44, provided:

- a) *the amenity of the surrounding properties is not adversely affected, in line with the provisions in Guidance G22 and Policy P41;*
- b) *the development does not detract from but enhances the streetscape; and*
- c) *the height limitation for the area is not exceeded.*

4.2.2 Side and back elevations

P42

SIDE AND BACK ELEVATIONS



In some instances the side and/or back elevations of a development may be more visible than the front elevation, particularly due to topographical changes or varying building heights, that give rise to visual implications in the medium-range. Specifically, there may be instances where the site:

- a) *lies within a series of back elevations where there is a uniform back elevation planimetry or typology;*
- b) *lies within or contiguous to an Urban Conservation Area;*
- c) *lies close to a Development Zone boundary, particularly when this happens to be a ridge edge;*
- d) *lies close to a scheduled property or a property that merits scheduling;*
- e) *lies contiguous to a different zone type, for instance contiguous to a detached dwelling area; or*
- f) *faces a green enclave or public open space.*

In these circumstances, due regard must be given to the design of the side and back elevations in terms of architectural quality. In particular, back elevations of new constructions or additions within Urban Conservation Areas or overlooking UCAs or ODZ areas should be well designed to harmonise with the traditional architectural characteristics

of the context and to improve areas of low quality. In order to assess their design implications, periti will also be required to submit these elevations and/or photomontages for their proposed development.

4.2.3 Façade projections and setbacks

The projection or setback of a building's front façade may contribute to the visual interest and variety in a streetscape, in line with the provisions in Guidance G23, and may furthermore provide articulated features on buildings, particularly if the latter are public buildings, in line with the provisions in Guidance G28.

P43

FAÇADE PROJECTIONS



It will not be allowed to project the building façade if such building is located in an Urban Conservation Area or sensitive environmental locations (Area Typology A3c). In other areas, building projections will only be allowed where there is a front garden, in order to respect the building alignment and to ensure the safety and convenience of pedestrians, cyclists and motorists.

Where allowed, a building façade projecting beyond the building alignment, or the alteration or extension of a building such that parts of its front façade project beyond the building alignment, will be designed in accordance with the following qualitative and quantitative provisions (Figure 60):

- a) *It will be designed as an integral part of the building, will not visually dominate the rest of the façade and will be constructed in materials which are compatible with those used on the remainder of the façade.*
- b) *It will be appropriate to the surrounding context and create a visually pleasing façade that does not look heavy but complements the remaining streetscape.*
- c) *The total projection will not take up more than 40% of the façade's total area.*
- d) *It will be allowed provided that there is a minimum distance of 2.75 metres (or as amended by Sanitary Law) measured from the finished pavement level.*
- e) *The maximum projection of 1 metre from the building alignment will only be allowed where there is a 3 metre front garden. If the front garden is less than 3 metres, the maximum façade projection will be worked at a relative ratio of $x/3$. Where there is no front garden, no façade projection will be allowed (Figure 61).*
- f) *The façade projection will be located at a minimum distance of 0.75 metres from the inner face of the party wall that is shared with the adjoining property so as to minimise potential amenity issues of overlooking into, or overshadowing of, such property.*

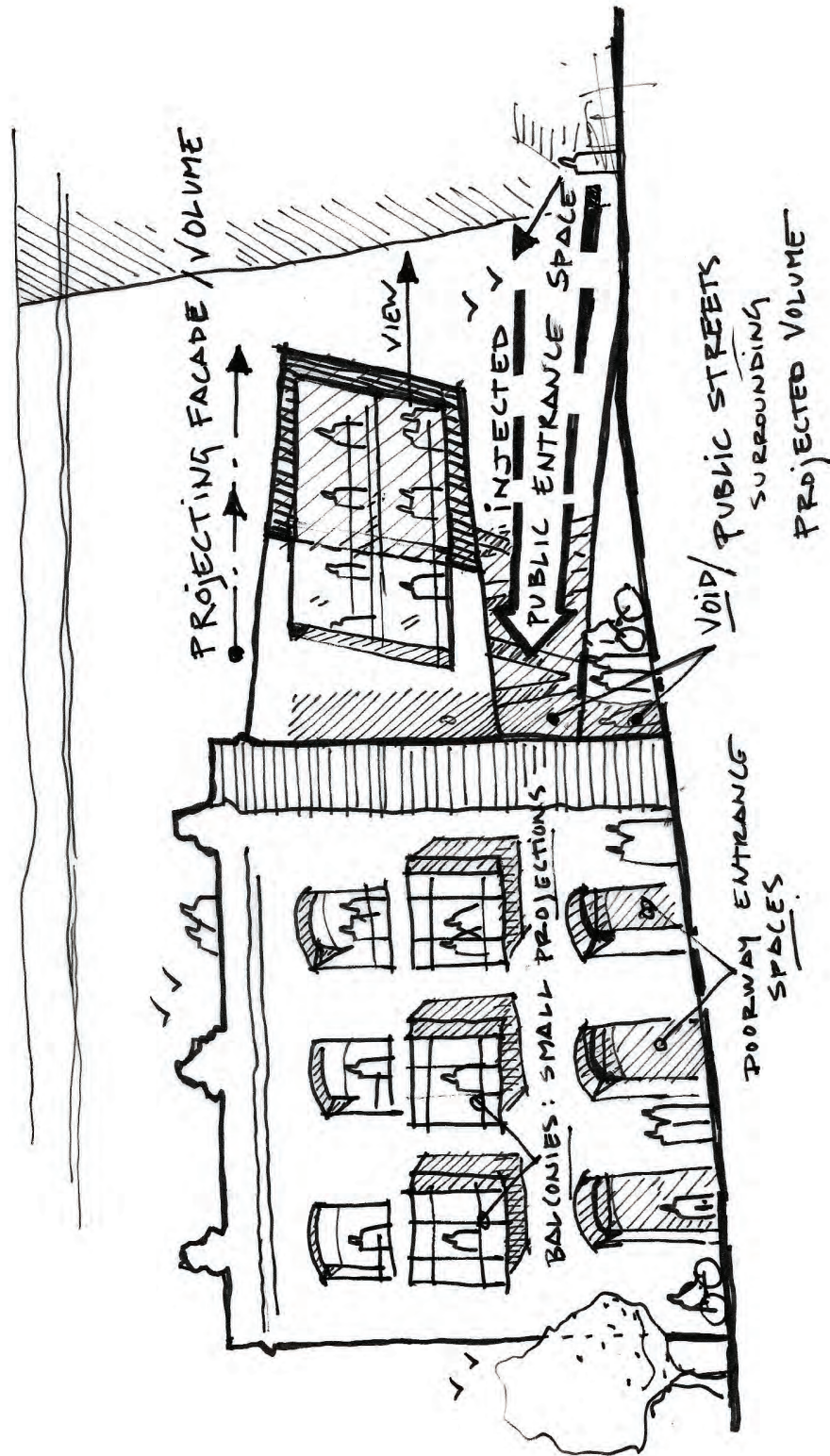

Figure 60: If well designed, a projecting façade may provide a positive contribution to the built environment

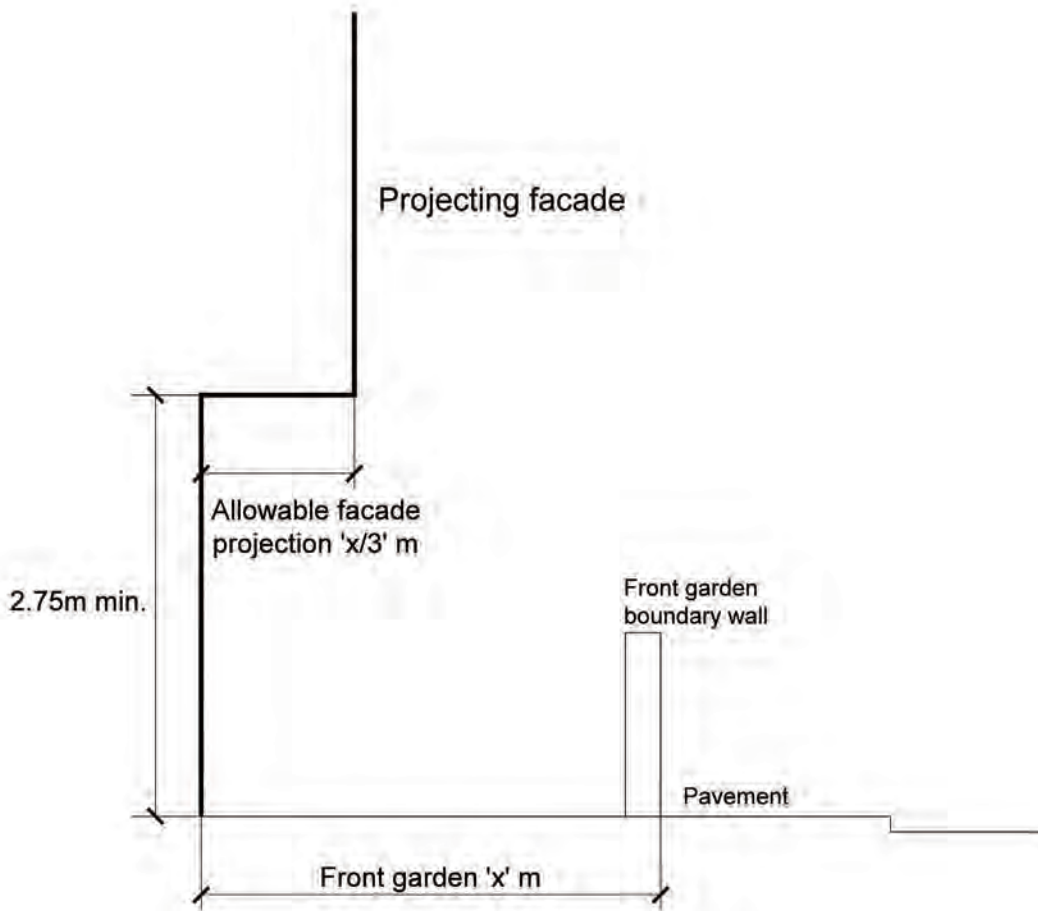

Figure 61: Façade projection – quantitative considerations

P44

FAÇADE SETBACKS



Façade setbacks at ground floor will only be allowed within Local Centres (A2), Villa and Bungalow Areas (A3b) and Commercial areas (A4b) in line with the provisions in Policy P34. On other floors, façade setbacks will be allowed both within these three Area Typologies and within Residential Areas (A3a).

Façade setbacks will be designed in accordance with the following qualitative and quantitative provisions (Figure 62):

- a) *The building on which such setback is to be applied will have a minimum frontage of 18 metres.*
- b) *They will be appropriate to the surrounding context and will create a visually pleasing façade that complements the remaining streetscape.*
- c) *No blank walls will be created as a result of such setback.*



Figure 62: *Well-designed façade setbacks that may create an interesting architectural treatment (top) and quality outdoor spaces at ground floor (bottom)*

4.3 DEVELOPMENT AMENITY AND SUSTAINABLE QUALITY

4.3.1 Development amenity and internal layout

P45 DEVELOPMENT AMENITY



All residential developments (including developments at high densities) will be designed with high amenity and accommodation standards. Issues with regard to the lighting, acoustic and olfactory aspects of environmental design are to be considered at design stage as part of the overall amenity of any development.

Subject to existing sanitary laws, such developments will be required to meet the following criteria:

- 1) **Plan depth:** Excessively deep plan houses or flats with inadequate natural light and ventilation will be avoided and in no circumstance will such depth exceed 30 metres, in line with the provisions in Policy P27. The applicant may furthermore be required to reduce the depth of the building where additional on-site landscaping or amenity space is desirable in line with provisions in Guidance G21.
- 2) **Outlook:** Any residential development (particularly apartment/flat developments) without an outlook will not be allowed.

Furthermore such developments will be required to provide:

- a) A satisfactory layout, indoor and outdoor living space for the intended level of occupation, including adequate external, domestic storage and refuse spaces, in line with the provisions in Guidance G24 and Policy P46. Central courtyards, backyards and gardens of all types and sizes are important elements within local architecture and provide light, air and recreational space to buildings, particularly those located within UCAs.
- b) Safe access for all residents, particularly vulnerable users, in line with the provisions in Policy P11;
- c) High amenity standards, in relation to visual and aural privacy in line with the provisions in Policy P41 and Standard S7; and
- d) Integrally-designed energy conservation and energy generation measures, in line with the provisions in Guidance G25 and Policy P48.

P46 REFUSE ROOMS



New multiple dwellings and high-density residential development serving 16 or more units will be required to make provision for a refuse room catering for the whole development which must be easily accessible from street level. The size of such room will be dependent on the number of dwellings being served and will be equipped with both organic waste and recycling bins.

This policy is an interim policy pending the approval of the Building Regulations.

G24

INTERNAL LAYOUT AND AMENITY SPACES



Further to the provisions in Policy P45, all developments should aim to make efficient use of space, avoiding unnecessary circulation or the formation of long and dark corridor spaces. Where corridors are inevitable, developments should aim to include breaks along their length, allowing light to permeate through.

As a general guideline, there should be the following area allowances within the minimum dwelling areas specified in Policy P32:

- An allowance of 10% of the gross floor area should be allocated as external space, which may be either open or covered, particularly to provide terraces for drying areas and for the placing of services in order to avoid having such facilities exposed on the street facades.
If such facilities are provided at the front of the building due to layout or space restrictions, such areas should be adequately screened by appropriately designed semi-solid screens, in line with the provisions in Guidance G47. On the other hand, if located within the building (including internal yards) or at the back of the building they should respect all the relevant provisions of this policy document and sanitary laws.
- An allowance for amenity space including domestic storage areas and laundry facilities; in the case of multiple dwellings, such facilities could also be provided in communal areas within the building.

4.3.2 Sustainable quality

G25

DESIGN FOR ENERGY CONSERVATION AND RESOURCE MANAGEMENT



The Authority encourages the consideration of specific energy conservation measures, the use of renewable sources of energy and resource management in the formulation of the design, layout and materials of all new developments, in view of producing nearly zero-energy buildings (Figure 63). Design measures should be targeted at prioritising the inclusion of passive measures in order to reduce the energy requirements of a development. Furthermore, where possible, existing passive measures such as those attainable through older building fabric should be retained and exploited. In this respect, spaces generated as a result of development or designed as part of such development should give due regard to issues, such as:

- daylight penetration;
- the control of sunlight, in terms of summer and winter variations as well as the implications for glare;
- the provision of optimal shading (as and where required);
- the consideration of prevailing wind and wind-flows and the avoidance of excessive wind speed generation; and
- resource management, namely opportunities for recycling and reuse, such as the provision for water collection and its reuse as a second class water resource.

*Specifically, the Authority encourages the consideration of the following passive design measures at the onset of the design process, which should be guided by the provisions in **Technical Guidance Document F – Conservation of Fuel, Energy and Natural Resources (Minimum Requirements on the Energy Performance of Buildings Regulations, 2006)**:*

- a) *Design of the building fabric that considers its thermal mass and the possibilities to incorporate thermal roof and wall insulation as well as green roofing technology, particularly on developments having a large roof area. For exposed roof surfaces, it would be good practice to use a light-coloured finish in order to avoid unnecessary heat gains.*
- b) *An internal building layout that gives due regard to room orientation and maximises passive solar design and cross-ventilation.*
- c) *The potential for shading external apertures and other building components in consideration of the building's orientation.*
- d) *The use of atria, lightwells and courtyards for the penetration of natural lighting and the achievement of cross-ventilation (particularly for summer cooling), contributing to an optimal microclimate.*
- e) *The location, size and glazing typology of external apertures in relation to the building's orientation.*

Regard should also be given to the use of renewable energy sources, particularly within developments having considerable roof space. These could include measures using solar energy and wind power. Guidance with regard to Solar Water Heaters (SWH) and Photovoltaic (PV) Panels is provided in Guidance G26. Other possible measures to consider include the installation of small domestic Wind Turbines (as defined in the Micro Wind Turbines policy), ground cooling systems, ground source heat pumps and solar air-conditioning.

For major projects and other development proposals where the use of energy and/or the potential for energy saving is considerable, the Authority may require the submission of an Energy Performance Prediction Audit in order to assess energy use and propose measures for conserving energy or improving its efficient use, in accordance with EU Directive 2002/91/EC on the energy performance of buildings.



Figure 63: Integrated energy conservation measures within buildings

4.3.3 Provision of water reservoirs and second class water reuse

P47

WATER RESERVOIRS



All new development should be provided with a water reservoir to store and re-use rainwater run off from the built up area and having a volume that is established in **Technical Guidance Document F – Conservation of Fuel, Energy and Natural Resources (Minimum Requirements on the Energy Performance of Buildings Regulations, 2006)**.

Relevant drawings (plans and sections) submitted with the development planning application are to show the proposed location of the water reservoir, its depth and resultant volume.

4.3.4 Photovoltaic Modules and Solar Water Heaters

G26

PHOTOVOLTAIC MODULES AND SOLAR WATER HEATERS



The Authority encourages the provision of Photovoltaic (PV) Modules as a means of generating electrical power, as well as Solar Water Heaters (SWH) as an effective means to reduce electricity consumption through their provision of hot water.

Due regard should nonetheless be given to their design in terms of their potential visual impact, particularly due to the angularity of the PV panels and SWH collectors, their overall bulk and, in the case of SWH, the reflectiveness of their materials, which could make them appear incongruous in certain positions, particularly on the roofs of buildings. For this reason the Authority encourages the introduction of PV modules and SWH in the following locations:

- a) At ground level within backyards where they may be mounted on the ground using freestanding frames, provided that their highest point would not exceed 3.4 metres above finished ground level. In villa areas, if mounted directly on the ground, their area will not be included as part of the site coverage.
- c) Within the building fabric or on the roofs of buildings – provided that the requirements in Policy P48 are met.
- c) In surface car parks and other open spaces, particularly those that may be provided within non-residential developments. PV modules may be mounted on freestanding frames having a maximum height of 3.4 metres.

Multiple PV modules and SWH may also be acceptable on a development provided that they each meet the above-mentioned criteria.

4.3.5 Integrated design of sustainable materials and systems

P48

INTEGRATED DESIGN OF SUSTAINABLE MATERIALS AND SYSTEMS



Where proposed, the Authority will demand that all energy conservation and energy generation measures be architecturally integrated within the built fabric and envelope. In line with the provisions in Policies P35 and P52, the height of buildings as designated within the Local Plans is to include services. Any placing of services above this height limitation will not be allowed.

Specifically, for both new and existing developments,

- a) Shading devices are to follow the provisions for the design of canopies in Policy P50.
- b) If located at roof level, Solar Water Heater (SWH) collectors as well as Photovoltaic (PV) modules will be directly mounted on the roof – inclined or flat – of the setback floor or roof structure as may be appropriate.
 - Inclined roof option (Figure 64): The roof inclination will be at an optimal angle and orientation for which most sunshine can be captured (locally taken at around 30 degrees). Due regard is to be given to the presence of other roof structures (and services, if applicable) such that there may be no overshadowing that would otherwise compromise the performance of the SWH collectors and PV modules, which would otherwise be unable to be oriented towards due south. There will be no requirement to setback the collectors/modules from the front and back edge of the inclined roof.
 - Flat roof option: Mounted on the roof at an optimal inclination, provided that (i) the height limitation is not exceeded and (ii) the void beneath the collectors/modules will be adequately screened (Figure 65a); or mounted flat (i) directly on the roof or (ii) at parapet wall level, provided that in both cases the height limitation is not exceeded (Figure 65b,c).

In the case of scheduled buildings and buildings located Outside Development Zone, SWH collectors and PV modules will only be mounted flat, directly on the roof.

In the case of SWH, the location of the ancillary storage tank is to be decided upon depending on whether a passive or active (pump) system is chosen. Other ancillary services may be subsequently located within the indoor ancillary/washroom space that is generated, in line with the provisions in Policy P52.

In the case of (b) above, submitted plans for the proposed development are to include the roof layout showing the location of the SWH collectors and/or PV modules. Sections are to clearly illustrate the inclined roof profile and the mounting of the SWH collectors and/or PV modules. Both drawings will form part of the approved drawing package.

- c) If designed as part of the built fabric, such as the façade, the character and appearance of both the development in question and its surrounding context will be assessed with regard to:
 - the overall visual impact of the installation on the building;
 - the relationship of the installation with the overall design of the building and the extent to which it has been satisfactorily integrated into that design;

- the overall visual impact of the installation on the site and its surroundings;
- the orientation of the building and associated requirements on PV systems; and
- the proposed materials.

In Urban Conservation Areas it will only be possible to design such measures on the back elevation, provided that this will not result in any negative visual impact. This will be particularly relevant in the case of exposed back elevations overlooking green enclaves and/or open spaces. For this reason, the integration of such measures will be assessed on a case-by-case basis.

Furthermore, in the case of (c) above additional visuals such as 3D renders and photomontages may be required by the Authority in order to assess the visual implications of the proposed design.

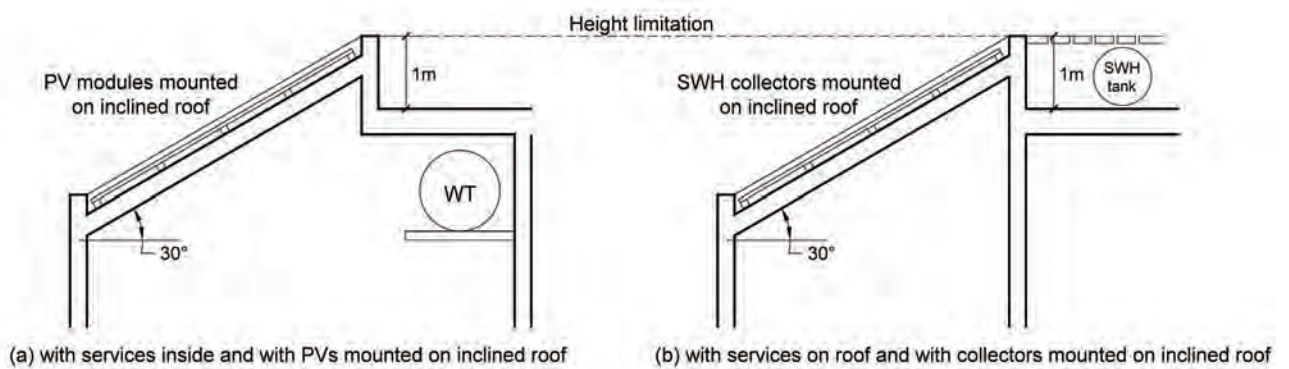

Figure 64: Inclined roof to take PV modules (left) and SWH collectors (right, option shown for a passive system)

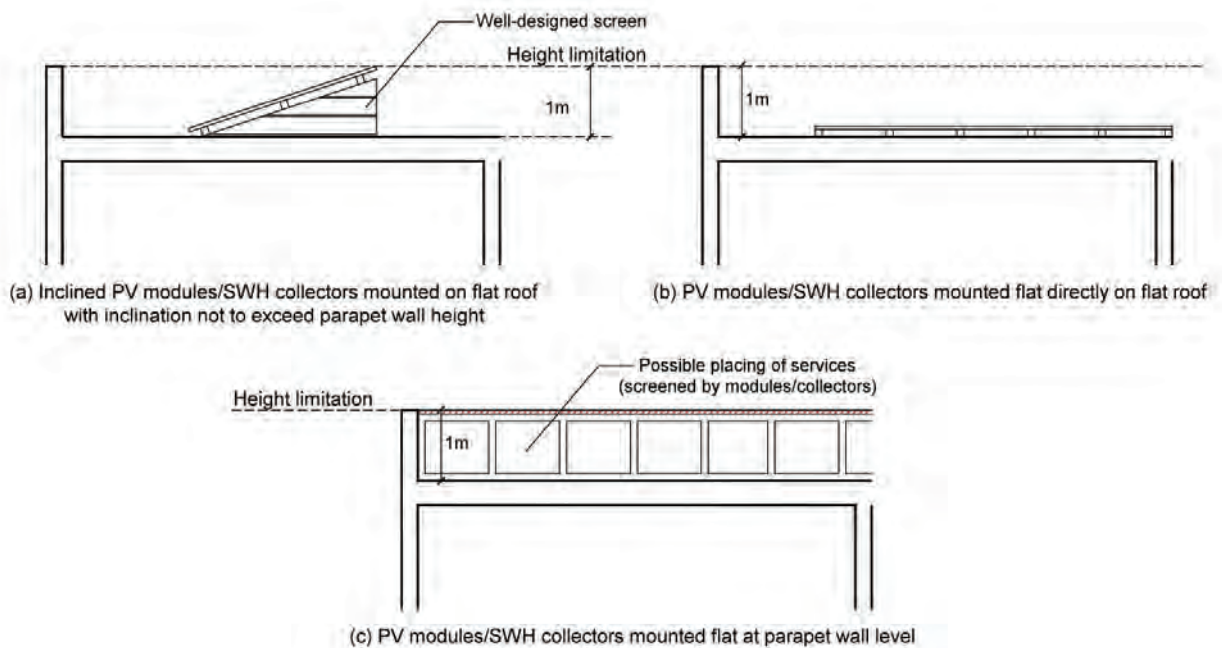

Figure 65: Options for PV modules and SWH collectors mounted on a flat roof

4.3.6 Prevention of light pollution

G27

PREVENTION OF LIGHT POLLUTION



Any proposed development or redevelopment should not be a source of light pollution, particularly at night. To this effect:

- a) *lighting should be strictly limited to within the developed part of the site and should direct light only where the light is required and only when the light is needed;*
- b) *the development should not be considered as a justification for the lighting of the access roads, tracks and paths leading to the site or other lighting beyond the site boundary;*
- c) *the lighting should be from any peripheral landscaping inward, so as to be screened as much as possible by the landscaping itself; and*
- d) *with the exception of architectural lighting on historic structures, all exterior lighting installed on site should be of the downward-pointing, full cut-off type which when installed at the specified design attitude gives zero intensity at and above the horizontal. No luminaire globes or up-lighters would be accepted.*

Any development planning application, particularly related to historical structures, which includes architectural lighting, is to be accompanied by a lighting scheme report endorsed by an independent Warranted Engineer certifying that the proposed lighting will minimise light pollution.

4.4 THE DESIGN OF PUBLIC BUILDINGS AND NON-RESIDENTIAL DEVELOPMENTS

This section deals with buildings that merit particular attention, due to their function, typology, scale and/or location, which elevates their contribution to the public realm (Figure 66).



Figure 66: Public and non-residential buildings – good design

4.4.1 Designing public buildings and non-residential developments – design principles

G28

THE DESIGN OF PUBLIC BUILDINGS AND NON-RESIDENTIAL DEVELOPMENTS



The Authority encourages high quality, innovative urban and architectural designs that respect and enrich their surrounding contexts, in line with the discussions in Part 1 of this document and the provisions in Guidance G1.

Public buildings and non-residential developments, particularly those located within designated areas/enclaves (A4b), offer significant opportunities for bold and imaginative architectural statements that add interest to the streetscape and act as landmarks, without diminishing the relevance of other established landmarks, in line with the provisions in Policy P37 (Figure 67). Such treatment may depart in certain respects from a particular provision given in this document, but may be acceptable provided:

- a) *the proposal is of high quality and may drive other high quality solutions;*
- b) *the development does not detract from but respects and enriches its context in terms of urban form, architectural quality and architectural elements;*
- c) *the amenity of the surrounding properties is not adversely affected; and*
- d) *green measures are implemented, such as green roofs/roof gardens and energy generation through renewable energy sources, particularly in developments characterised by a large roof area, including commercial and industrial developments, and social, cultural, religious and educational establishments.*

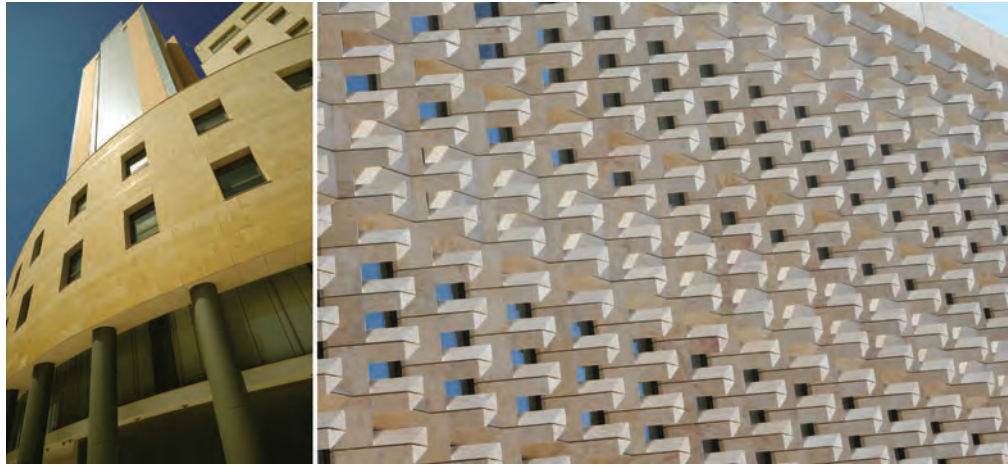

Figure 67: Public and non-residential buildings – good detailing

4.4.2 Medium- to large-scale non-residential developments

G29

MEDIUM - TO LARGE-SCALE NON-RESIDENTIAL DEVELOPMENTS



The design of medium- to large-scale non-residential developments requires special care due to their particular requirements for prominence and for the use of space, which may demand:

- *occupying a significant footprint, with resultant roof area;*
- *having higher than normal floors, which are to follow the provisions established in Guidance G18;*
- *making a design statement, due to the particularity of their function or to signify attractiveness, innovation or modernity; and*
- *having large glazed areas or particular façade treatments.*

While acknowledging the need to cater for the above requirements, these developments should nevertheless be guided by the following provisions:

- a) *They should respect and relate to their contexts, particularly when located within Local Centres (A2), Residential Areas (A3a) and Mixed-Use Areas – predominantly residential (A4a), following the principles discussed in Part 1 of this document and the general direction established in Guidance G1.*
- b) *They should follow the provisions for building heights of non-residential developments, established in Policy P37.*
- c) *They should be designed to be adequate for their proposed purpose and capable of usage for a variety of purposes (in relation to such use) with minimal adaptation or alteration.*
- d) *They should relate to the human scale, giving due regard to the design of the ground floor, notably the treatment of the entrances and other spatial interfaces in line with the provisions in Guidance G22, as well as the possibility to introduce an element of active frontages, in line with the provisions in Guidance G19.*
- e) *Large glazed areas, if deployed, should be handled carefully, particularly when viewed in relation to the solid to void ratios and aperture proportions present within the surrounding streetscape and broader context, in line with the provisions in*

Guidance G43. Apertures are also to follow the provisions regarding privacy established in Policy P41, particularly when non-residential developments are adjacent to residential buildings.

- f) *Materials used on exteriors are to follow the provisions in Guidance G49, with the potential to deploy a higher element of contemporary, creative and innovative materials.*
- g) *The roof area should be exploited for recreational purposes as well as for the integration of green measures, notably the development of green roofs/roof gardens and the provision of PV modules, in line with the provisions in Guidance G25. Use of such roof would be appropriate where this would not lead to a reduction in privacy or amenity of adjoining buildings. Generally, however, the use of the roof of a non-residential development located within or immediately adjoining a residential area would not be allowed for (i) operational purposes; (ii) car parking; or (iii) any other use that would have an adverse impact on the amenity of the area.*
- h) *Where non-residential development adjoins residential areas, then particular care should be taken over the design of new non-residential buildings so as to ensure that there are no adverse amenity impacts. Transition design solutions in the form of well-designed buffer zones may be required at interfaces, in line with the provisions in Policy P6.*
- i) *Possible social and environmental effects (notably noise, vibration, fumes, smell, smoke, other atmospheric pollution, effluent discharge and contamination of land) of non-residential developments (including issues in relation to operation) should be studied in depth and may be the subject of studies and impact assessments.*
- j) *In line with the provisions in Policy P52, significant opportunity exists within these developments to relocate services underground and to integrate building services within the design of plant rooms.*

4.4.3 Industrial developments

G30

INDUSTRIAL DEVELOPMENTS



New industrial buildings, conversions of existing buildings to industrial use and the extension of industrial buildings should be designed in line with the provisions in Guidance G29. Furthermore, provision should be made for:

- a) *Adequate access and for off-street servicing arrangements, including commercial/heavy goods vehicle parking and adequate spaces for loading/unloading and manoeuvring (in accordance with the policies in Part 2 of this document).*
- b) *Goods lift servicing where the upper floor(s) are to be used for industrial or storage purposes.*
- c) *The minimisation of the production of solid and liquid waste, and for improved waste separation, storage and recycling, through the introduction of closed-loop systems.*
- d) *Appropriate storage areas within the curtilage of the industrial unit. In the event of external waste storage areas these are to be appropriately protected from the elements and contained to prevent spreading of waste or discharge of effluent.*
- e) *The inclusion of wall grilles and/or stacks and vents within the buildings. Where these cannot be located on façades, internal yards should be of adequate size so as to allow the installations of such structures including possible abatement and filtration equipment.*

4.5 THE DESIGN OF SHOP FRONTS

4.5.1 Shop fronts – general design principles

G31

SHOP FRONTS – GENERAL DESIGN PRINCIPLES



Shop fronts provide a critical contribution to successful streets, in line with the principle of creating important active frontages at ground floor, as established in Guidance G19. For this reason, a high level of design quality should be sought, to furthermore ensure that shop fronts are respectful of the building in which they are situated and to the character of the streetscape and broader context within which they are located (Figure 68). Poor-quality design would otherwise result in serious damage to the streetscape, particularly at ground floor level.

Issues in relation to size, scale, appropriate design and detailing, the correct use of elemental components (notably apertures, fascias, canopies and blinds, signs, illumination and shutters) together with materials and colour schemes are important in achieving high-quality shop fronts. Brash designs, large lettering, bright colours and incorrect usage of illumination may result in a disturbing array of shop fronts that relate neither to the buildings that house them nor to each other.

The following general design principles apply to most forms of shop front proposals:

- a) *Approval would not be given where original architectural features that are worthy of preservation are to be removed or concealed.*
- b) *There would be a general presumption against new openings in scheduled properties and properties within Urban Conservation Areas.*
- c) *The character, scale, proportions and detailing of the building above and of adjacent properties should be respected.*
- d) *Where a retail unit is proposed, which includes more than one individual building or facade, shop fronts should be individually designed for each facade with some form of separation in order to maintain a correct rhythm within the streetscape and give due regard to the human scale, respecting façade proportions in line with the provisions in Guidance G16.*
- e) *Innovative contemporary design would be acceptable as long as it is of high-quality, is respectful of the architectural characteristics of the building in which it is to be situated, and furthermore relates and enriches the context within which such shop front is located, in line with the discussion in Part 1 of this document and the provisions in Guidance G1.*
- f) *The design of individual elements including apertures, fascias, illumination, security shutters and signs, as well as issues in relation to materials and colour, are to follow the respective provisions in Part 5 of this document.*



Figure 68: Shop fronts offer an important contribution to the shopping street and its surrounding context

4.5.2 Retention and replacement of existing shop fronts

G32

EXISTING SHOP FRONTS



Where the existing shop front provides a valid contribution to the character of the building or the broader context, it should normally be retained rather than replaced (Figure 69), particularly in scheduled properties and properties within Urban Conservation Areas. These considerations have further weight in the Capital City of Valletta, given its designation as a World Heritage Site.

Traditionally, most shop fronts are small, each frontage being unique due to its own individual design, yet respecting the form of the building above and frontages to either side. This gives the shopping street rhythm and harmony without monotony. Within urban cores shop fronts have often consisted of a simple arched opening, with little in the way of signage or window display. Creating larger openings in these situations may destroy much of the character of these traditional buildings. The retention of traditional shop fronts and traditional shop signs on heritage buildings, particularly scheduled properties and properties within Urban Conservation Areas would therefore usually be a requirement, even if the shop front may not be contemporary with the original building.

Many shop fronts from the 19th and early 20th century periods abound, several of which have been scheduled, and these contribute positively to the areas in which they are situated. Features such as mullions and transoms, which help break up the large expanse

of glass within apertures and to relate it to the human scale, or architectural details and ornamentation (such as pilasters or cornices) surrounding apertures, as well as materials used in original traditional shop fronts (generally wood with a painted finish and ironwork), as well as traditional shop signs (generally directly painted on glass or wood) should be retained wherever possible or restored or reproduced in materials that do not detract from the original design of the shop front.

Where the nature of the business changes, the original scheduled shop front and sign/s should be retained and an alternative shop sign that is reversible may be placed over the original sign.

If the original shop front has deteriorated to such an extent that it cannot be retained then it should be replaced. In the case of many unsympathetic post-war shop fronts this would present an opportunity to improve upon the present situation, particularly if the original shop front would still be surviving beneath later additions and may be capable of restoration.

New shop fronts should follow the provisions in Guidance G31 and respect the design and materials of the building into which they are to be fitted, including the original design of the aperture. Building widths and vertical subdivisions in the form of fenestration, columns and pilasters should be reflected in new designs to maintain a vertical emphasis. The horizontal emphasis provided by a consistent fascia line, transoms and glazing heights should also be respected. The shop front should not attempt to divorce the ground floor from the rest of the building or over emphasise the fascia.

Where a retail unit is proposed which includes more than one individual building or façade, shop fronts should be individually designed for each façade with a separation between the fascia boards.

Designs should also give regard to the characteristics of adjoining shop fronts in the street, possibly including stylistic considerations. This would be even more critical in the case of a single building that has been sub-divided into a number of smaller units (such as an arcade of shops).



Figure 69: Retrofitting an existing commercial premises including existing shop fronts

4.6 ARCHITECTURAL QUALITY – QUALITY CHECKLIST FOR *PERITI*, ASSESSORS AND DECISION-MAKERS

Neighbourhood amenity

- Is the development a good neighbour to adjoining buildings or public areas? Are the proposed uses compatible?
- Does the development give regard to existing public open spaces?
- Is there scope to generate new public spaces through the proposed development that are accessible and linked to other spaces, and that may increase the amenity of the surrounding neighbourhood?
- Does the development create safe and secure environments and are there opportunities for natural surveillance?
- Are the interfaces between public and private space clearly defined? Do semi-public and semi-private spaces transition adequately into the public and private areas respectively?
- Does the development have an active frontage, are its entrances clearly recognisable and do they create a sense of activity and security?
- Does the development respect privacy of neighbouring buildings and are privacy distances complied with, or does the design incorporate measures to mitigate any potential impacts to privacy?

External appearance

- Is the architectural design innovative and does it endeavour to achieve excellence in terms of design quality?
- Is the development to be a major landmark, a local focal point or a backdrop development? Is this reflected in the architectural design?
- Is the design concept adequate to the broader context within which the development is located?
- Where visible, have side and back elevations been well designed with regard to their visual implications?
- Do the façade projections and setbacks relate well to the overall proportion of the development and do they offer a positive contribution to the streetscape?

Development amenity and sustainable quality

- Does the development have a good internal layout and does it seek to address any planimetric limitations appropriately?
- Does the layout allow for ancillary spaces (such as the provision of service areas and external areas) and has it been designed in line with high amenity and environmental standards?
- Does the development offer a good outlook for its prospective users?
- Has the development given due regard to key environmental issues and has it taken into account passive design measures from an energy conservation point of view?
- Is resource management a central consideration of the development? What tangible measures have been taken into account, particularly in terms of recycling and reuse?
- Does the design aim to produce a nearly zero-energy building?
- Are renewable energy sources incorporated within the design of the development and have they been designed in an integrated manner?
- Does the development provide for water collection and its possible reuse?
- Have the visual implications of PV modules and SWH collectors been addressed and have both quantitative and qualitative considerations been taken into account in their design?

The design of public buildings and non-residential developments

- Is the design of the public building or non-residential development of high architectural and environmental quality and does it provide an impetus to the design of surrounding buildings?
- Does the design respect its context and the amenity of surrounding developments?
- Does the architectural design have the potential to become an important landmark in the years to come?
- Do the uses at ground floor add vitality and security to the surrounding spaces at different times of day and night?
- Has the medium- or large-scale development been designed well with regard to its scale, bulk and proportion, in terms of the human scale and other surrounding developments and does it seek to exploit its scale favourable in terms of amenity and the provision of green elements?
- Does the medium or large-scale development seek to mitigate any adverse impacts due to its use or scale and are such mitigation measures reflected in its design?
- Does the industrial development adequately address access and service requirements as well as waste generation? Are unsightly uses located out of sight and are there design interventions to address their visual impact?

The design of shop fronts

- Does the design of the shop front create an attractive active frontage for the public realm?
- Are the original architectural features incorporated in the design of the new shop front or have they been removed?
- Is the design of the shop front respectful of the larger context wherein it is located, have important streetscape parameters been respected and how does the design fit in with that of adjoining buildings?
- Does the shop front occur in a heritage building and if so have the architectural interventions been addressed successfully?
- Does the shop front seek to replace existing traditional shop fronts? Is there scope for the retention of the original shop front, rather than its replacement?
- If interventions are proposed on existing shop fronts, have these been done in a sensitive and reversible manner and do they fit in with the architectural design present within the street?



05

ARCHITECTURAL ELEMENTS

- 5.1** INTERPRETATION OF, AND ALTERATIONS TO, EXISTING ARCHITECTURAL ELEMENTS AND FEATURES
- 5.2** SECONDARY ELEMENTS
- 5.3** OPENINGS
- 5.4** BALCONIES
- 5.5** SERVICES
- 5.6** MATERIALS AND FINISHES
- 5.7** COLOUR
- 5.8** ARCHITECTURAL ELEMENTS – QUALITY CHECKLIST FOR PERITI, ASSESSORS AND DECISION-MAKERS

05

ARCHITECTURAL ELEMENTS

Part 5 deals with the most elemental level of architectural design, at a finer level of detail, and provides the greatest level of flexibility and possibility for individual interpretation and freedom, within the parameters established in the previous Parts for a contextual approach, urban form and architectural quality. As a result, the majority of the provisions are good-practice guidance that provides general design intent without being overly prescriptive. As with Part 4, it is equally being acknowledged that there might be more than one acceptable solution, or interpretation, of the provisions in Part 5 that cannot be excluded a priori.

The Part commences by outlining important considerations with regard to the interpretation of, and alterations to, existing architectural features and elements (Section 5.1). It subsequently identifies different architectural components, including secondary elements (Section 5.2) such as open staircases, fixed/demountable structures, canopies, awnings, shop front elements and cantilevers and elements located within urban areas, notably trees and street furniture; openings, apertures (Section 5.3) and balconies (Section 5.4); and services (Section 5.5), relating back to other considerations dealt with in Part 4 with regard to the design integration of sustainability measures. The Part ends with important contributors to the external appearance of a building, focusing on materials and finishes (Section 5.6) and colour (Section 5.7) (**Figure 70**).

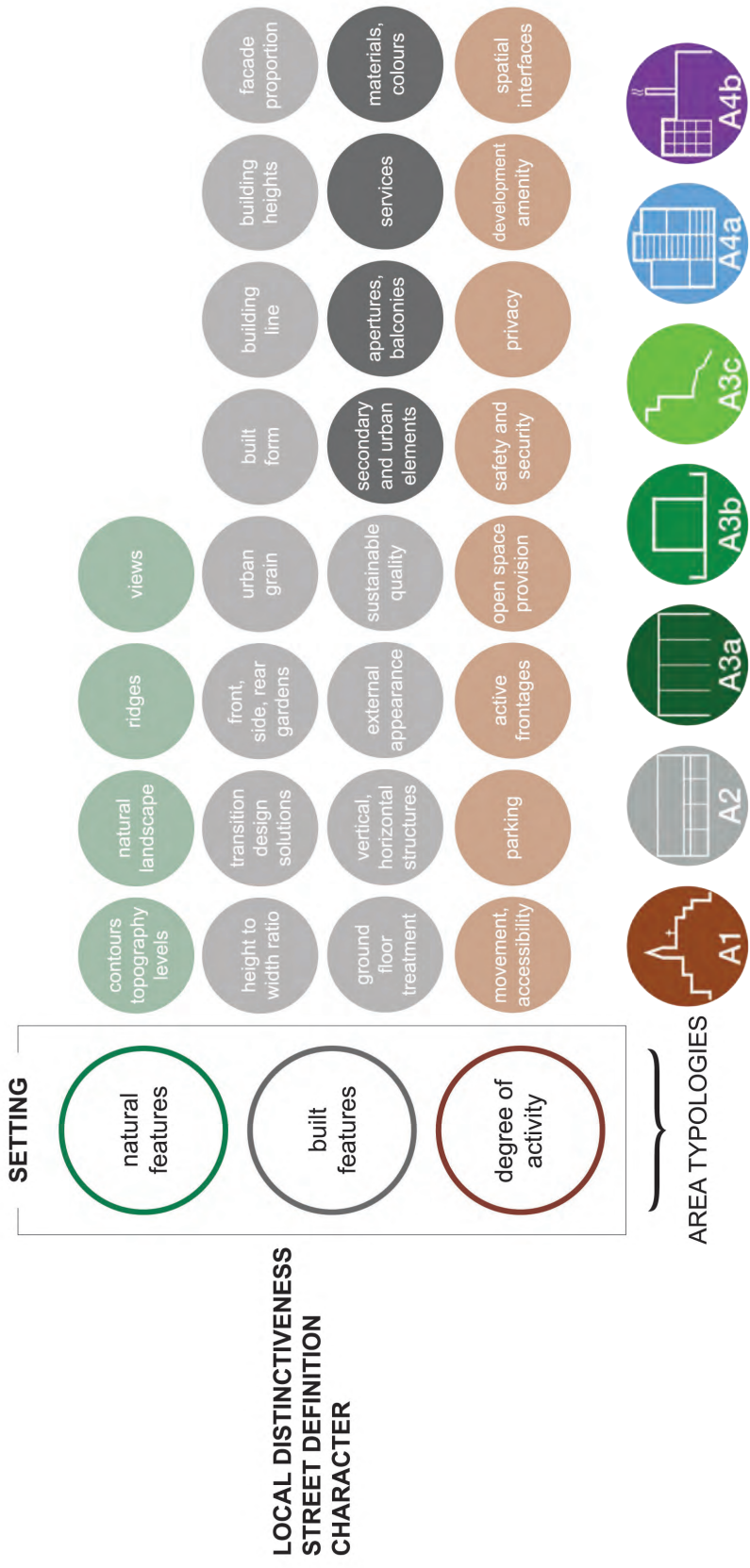

Figure 70: Contributors to setting, local distinctiveness and streetscape – the remit of Part 5 is highlighted

5.1 INTERPRETATION OF, AND ALTERATIONS TO, EXISTING ARCHITECTURAL ELEMENTS AND FEATURES

G33

INTERPRETATION OF, AND ALTERATIONS TO, EXISTING ARCHITECTURAL ELEMENTS/FEATURES



In the design of new developments and/or redevelopments the question often arises as to how one should interpret existing architectural elements and features.

In a number of cases, parameters in relation to 'urban form' and 'architectural quality' will be more significant than individual architectural elements. Such is the case with the design of semi-detached dwellings, in line with the provisions in Policy P29.

Within infill (terraced) developments, particularly those present within Urban Conservation Areas (A1) and Local Centres (A2), there may be architectural elements and/or features present:

- a) *within the previous development being replaced that are worth retaining; and/or*
- b) *within neighbouring developments that are worth repeating,*

due to their significant architectural and contextual relevance and the consistent rhythm that they bring to the street, in line with the provisions in Guidance G3 and Local Plan provisions, for instance through the designation of street Categories in UCAs or the scheduling of buildings (Figure 71).

In the case of (b), unless the building is one of a series adjacent to each other, the approach should not be on slavishly copying, or replicating the architectural elements/features in question without giving due regard to the contextual implications discussed in Part 2 of this document. Indeed, the broader relevance of such elements/features to the streetscape should first be studied; following which the optimal manner with which such elements and/or features should be interpreted may be determined, keeping in mind that where possible one should strive to produce an architectural language that speaks of its time. Such elements/features may include vertical or horizontal lines/façade divisions provided by stone mouldings, which provide an important contribution to a streetscape and which should be respected. At the same time, however, there may be instances where in new additions and/or redeveloped façades these may be interpreted as plainer variations that clearly distinguish them from the original features while nonetheless relating back to such motifs.

In other cases, an entirely different contemporary architectural solution might be more appropriate and acceptable, in line with the provisions in Guidance G3. Great care, however, must be taken in order to ensure that the injection of such new elements does not diminish, or impoverish, the value of the very same context within which they are to be located (Figure 72).

Alterations to existing architectural elements/features in Urban Conservation Areas

In Urban Conservation Areas and scheduled properties, alterations to façade elements, such as the conversion of persjana doors into windows; modifications to door and/or window proportions; and any alterations to cornices, string courses, mouldings, niches, and other façade elements would not be acceptable on Grade 1 buildings and there would be a

presumption against changes in façades Grade 2 buildings. Changes to façade elements of Grade 2 and Grade 3 buildings would only be favourably considered if they are in context with the historic built environment and are intended to improve the original façade. Further guidance regarding the design of openings is provided in Guidance G43.*



Figure 71: Well-crafted addition to existing building, reflecting original architectural elements



Figure 72: Successful contemporary addition and alterations to existing building

5.2 SECONDARY ELEMENTS

5.2.1 Open Staircases

G34

OPEN STAIRCASES



Open staircases are required in the design of accesses to elevated ground floors (where a basement level is allowed) or to the roofs of bungalows (in line with the provisions in Policy P40). They may also be required as part of specific design solutions, such as external staircases in special buildings that also double up as fire escapes.

In these circumstances, the construction of an open staircase on the façade or side elevations of a building would only be allowed within the front garden or side curtilage respectively. Such staircase should be:

- a) designed as an integral part of the building and, in particular, be of an appropriate size and shape in relation to the building, such that it does not appear bulky on the façade;
- b) appropriate to the overall architectural design being sought within the building and should visually enhance such building;
- c) proposed to be constructed in materials which relate to both the building (particularly the remainder of the elevation of the building to which the staircase will be attached) and the streetscape within which it is located;
- d) set back from the street alignment at an adequate distance if a gate is to be installed, which should furthermore open inwards; and
- e) where possible, constructed as a straight run of risers for a maximum height of 1.6 metres above finished pavement level.

With regard to (e), the degree to which the staircase should project from the façade would depend on the function of the building, the number of people using the staircase and frequency of such usage. Nevertheless, U-shaped staircases or similar configurations that occupy more than 50% of the front garden area would be unacceptable (Figure 73).

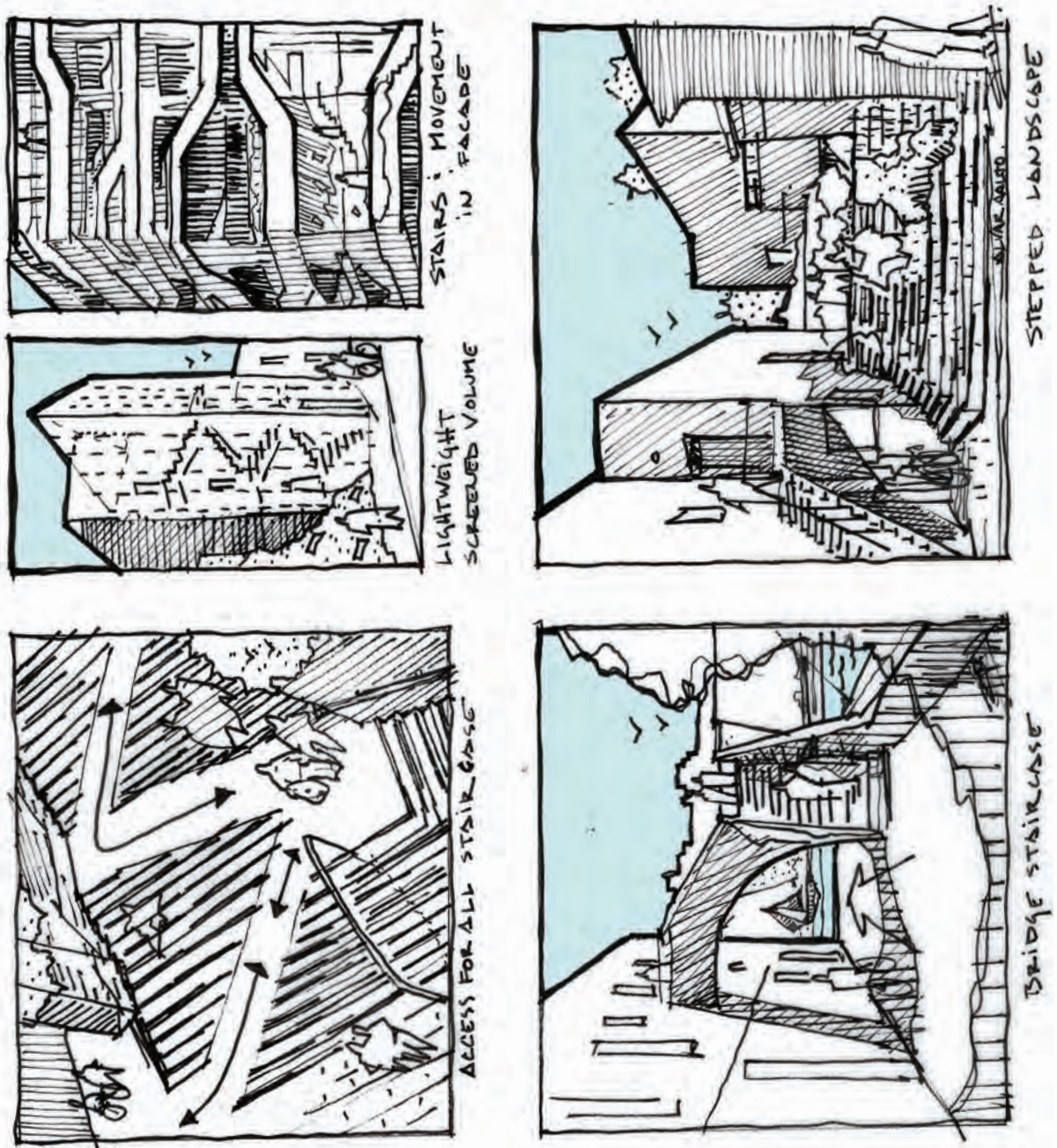

Figure 73: Positive contribution of open staircase to architectural composition

5.2.2 Applicability and design of fixed/demountable structures, canopies, awnings

P49

APPLICABILITY OF FIXED/DEMOUNTABLE STRUCTURES, CANOPIES AND AWNINGS



The applicability of fixed and demountable structures, canopies and awnings within private outdoor areas will be guided by the following table (Table 6).

Area Typology	Plot/building considerations	Fixed structure	Demountable structure	Canopy	Awning
A1	on façade	X	X	X	✓
A2	f.g.	✓	✓	✓	✓
	no f.g., GF	X	X	✓	✓
	no f.g., above GF	X	X	✓	✓
A3a	f.g.	X	✓	✓	✓
	no f.g., on façade	X	X	✓	✓
A3b	f.g.	✓	X	✓	✓
	on façade	X	X	✓	✓
	6m s.c.	X	X	✓	✓
	3m s.c.	X	X	✓	✓
	back yard/garden	✓	✓	✓	✓
A3c	on façade	X	X	✓	✓
A4a	f.g.	✓	✓	✓	✓
	no f.g. on façade	X	X	✓	✓
A4b	f.g.	✓	✓	✓	✓
	no front garden	X	✓	✓	✓
N/A	heritage building	X	X	X	✓

Note:

f.g. = front garden; GF = Ground Floor; s.c. = side curtilage

Table 6: Applicability of fixed, demountable structures, canopies and awnings

The design of fixed, demountable structures, canopies and awnings is to be guided by the design parameters in Policy P50.

For Outdoor Catering Areas on public open space reference is to be made to the policy document Policy, Guidance and Standards for Outdoor Catering Areas on Public Open Space.

P50

FIXED AND DEMOUNTABLE STRUCTURES, CANOPIES AND AWNINGS – DESIGN PARAMETERS



Where allowed, except for Outdoor Catering Areas on public open space, the design of fixed and demountable structures, canopies (Figure 74) and awnings (Figure 75) is to be guided by the following provisions:

- a) *Fixed and demountable structures and canopies will not project more than 1 metre from the building alignment. When fully extended, awnings will not exceed 1.5 metres from the building alignment, but in cases where the road width between the commercial outlet and the opposite building is less than 8 metres, the awning shall not extend over more than 0.75 metres.
In any case, where the awning extends over an existing pavement it will be at least 0.5 metres from the pavement edge. In the case of food and drink outlets with a front garden, the awning shall not extend beyond the edge of the front garden area.*
- b) *If permissible at ground floor, at their highest point, they will not be higher than 3.4 metres and at no point will be less than 2.1 metres above ground level.*
- c) *They shall visually relate to the façade of the building, have appropriate proportions (in terms of size, form and shape) in relation to (i) the width of the street; (ii) the available pavement or front garden space; (iii) the adjoining buildings; and (iv) the width of the aperture against which they are to be installed. The width of an awning shall not extend beyond the width of the aperture in the case of shop fronts and shall only be allowed to extend beyond the aperture width in the case of food and drink outlets.*
- d) *They shall be high quality elements, designed to the highest technical specifications, and will visually enhance the streetscape. Structures shall not be permitted if they will disrupt the architectural equilibrium or rhythm of the façades in the streetscape. On heritage buildings, particularly scheduled properties and properties within Urban Conservation Areas preference will be given to flat-type awnings.*
- e) *They shall be constructed in appropriate materials – in the case of demountable structures and canopies, in lightweight materials such as timber, wrought iron, steel and glass; and in the case of awnings, in hard-wearing woven fabric that may be stretched over the supporting structure and not be glossy in appearance. Structures shall not be permitted where they would obscure architectural details or features on the façade.*
- f) *They shall be designed in appropriate colours, which are to be sensitive to the individual contexts wherein they are located. Simple, uniform colours shall be used; being muted in tone rather than brash or loud and there shall be a preference for a single colour or two complementary colours.
No advertisements will be permitted on the structures or awnings except for the name of the non-residential development in question, which in the case of awnings shall be restricted to the skirt.*
- g) *They shall not give rise to any loss of amenity, such as daylight penetration, or to any issues in relation to safety, security and privacy to an immediately adjacent or overlying property used for residential purposes.*
- h) *In non-residential developments located at ground floor, the awnings shall only be in place for the hours of operation of the non-residential use and will therefore be easily retractable.*



Figure 74: Canopy/shading device (left) and retractable awning (right) deployed on the façade of buildings

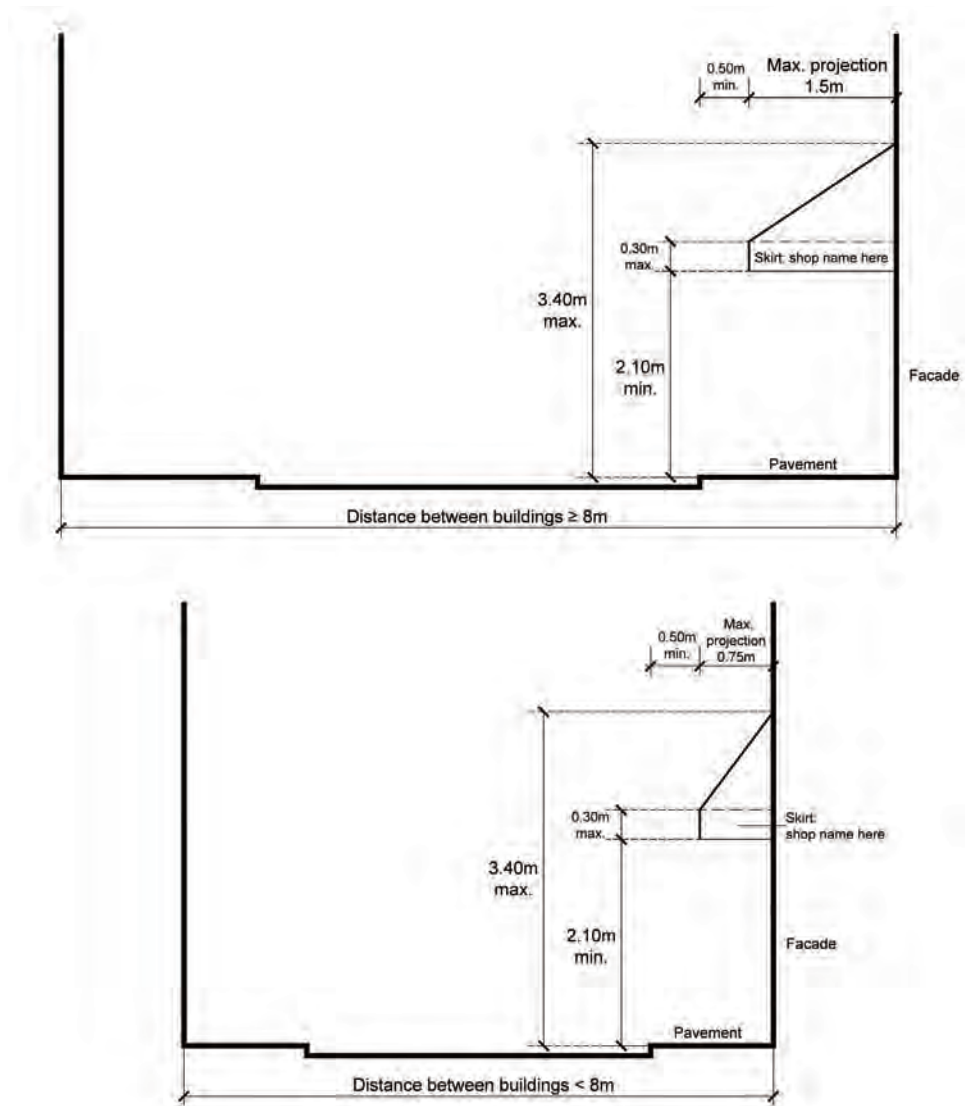

Figure 75: Awnings – key design parameters

G35**ALLOWANCE FOR PERMANENTLY FIXED AND ENCLOSED STRUCTURES**

Permanently fixed and enclosed structures in the front gardens of food and drink outlets may be permitted within areas identified by the Authority specifically for this purpose, guided by the following provisions:

- *They should not give rise to loss of light, privacy or security of an immediate adjacent ground floor or overlying property used for residential purposes.*
- *Any enclosure should have a high quality design and be of a temporary, retractable nature so as to provide protection from weather conditions as and when required.*
- *They should look visually 'light' and avoid the use of aluminium or external steel security grills (shutters).*
- *They should follow provisions (b), (c), (d), (e) and (f) in Policy P50.*

5.2.3 The design of shop front elements

Shop front elements that are dealt with in this section comprise: the fascia, illumination, projecting and hanging signs and security shutters.

G36**SHOP FRONT FASCIA**

As the most noticeable element of a shop front, the fascia should be designed in an integral manner, giving regard to the following design parameters (Figure 76):

- a) *The height of fascia boards should be kept to a minimum and respect the proportions of the building and original facade.*
- b) *The fascia should not alter or conceal any apertures, architectural features or façade ornamentation, such as arches, pilasters, columns or supporting corbels.*
- c) *Signs or advertisements should not normally be placed above fascia level, excluding projecting signs.*
- d) *New fascia boards should not project forward of the face of any original fascia.*
- e) *The existence of a former unsuitable fascia should not influence the design of any replacement; rather, the opportunity must be taken to remove the existing fascia and to reinstate the original fascia size.*
- f) *The fascia's materials and colours should be compatible with the building, in line with the provisions in Guidance G50 and G52 respectively. Glossy or highly reflective materials are not generally suitable, particularly in Urban Conservation Areas. Matt finish fascia boards, particularly painted wood, are preferred. Traditional primary colours (such as dark green, navy blue and dark red) should be used wherever possible.*
- g) *No new or extended fascia boards will be allowed on scheduled properties and properties within Urban Conservation Areas, except for the replacement of an existing fascia unless scheduled. Such replacement should be of the highest design quality, paying attention to the use of traditional materials and workmanship.*



Figure 76: Well-designed shop front fascias

G37

SHOP FRONT ILLUMINATION



The illumination of fascias requires careful consideration because it can give undue prominence to one element of the facade and extend visual impact over a wider area. Shop fronts do not require illumination if the level of street lighting and the light from shop windows is adequate.

In Urban Conservation Areas illuminated signs should be designed to be least intrusive and located in the main commercial streets. Internally illuminated box signs produce a crude visual effect and are inappropriate in historic areas. More subtle and acceptable solutions may be provided in appropriate locations, by externally illuminated fascias with carefully directed light beams or backlit or halo-lit letters.

The illumination of fascias would not normally be allowed on scheduled properties and properties within Urban Conservation Areas. In exceptional circumstances illumination may be allowed on premises that are open at night, such as bars and restaurants, but only during hours of business.

Illumination should always be used with great care and restraint and the following provisions should guide the lighting design for shop fronts (Figure 77):

- a) *Downlighting is generally preferred to internally illuminated box signs.*
- b) *If there is no alternative to uplighting then use should be made of light fittings containing appropriate shields that may help reduce light spill to a minimum.*
- c) *External spotlights should not be obtrusive but discreetly hidden on suitable parts of the building.*
- d) *Projecting light fixtures to illuminate shop signs add clutter and should be avoided, particularly within residential areas and Urban Conservation Areas, unless they harmonise with the shop sign's design and the broader architectural context.*



Figure 77: Well-designed shop front illumination

G38

SHOP FRONT SECURITY SHUTTERS



Shop front security shutters must be selected with care and, where possible, existing original/traditional shutters that retract into blind boxes fitted flush with the fascia should be retained and refurbished. Furthermore (Figure 78):

- a) Heavy metallic shutters, are unattractive and create dead frontages that do not provide a positive contribution to the street. If used, they should be of the 'see-through' type rather than the solid type. Where possible, however, existing traditional wooden shutters that are more welcoming should be retained and restored.
- b) The use of laminated glass or internal lattice grills would be preferable to external shutters.
- c) Shutter boxes must not be conspicuous on the façade of the shop.
- d) Advertising or lettering would generally not be acceptable on shutters of heritage buildings, particularly scheduled properties and properties within Urban Conservation Areas.



Figure 78: Well-designed (left) and poorly detailed (right) shop front security shutters

G39

SHOP FRONT SIGNS



Only one sign should be fixed to each shop, in order to contain the visual clutter that would otherwise arise. The sign should be positioned so as not to obscure or damage architectural features, or cause obstruction, annoyance or danger to passers-by or the adjoining shop. Projecting signs would not normally be allowed on scheduled properties and properties within Urban Conservation Areas.

5.2.4 Cantilevers at roof level

G40

CANTILEVERS AT ROOF LEVEL



There would be a general presumption against introducing a cantilever at roof level, since this could detract from the clean termination/roofline that a solid parapet wall may provide to a building façade.

Nevertheless, if it may be established that:

- there are numerous other similar commitments for cantilevers at roof level within the street; and
- a cantilever would provide a practical and design function to the building, it may be acceptable provided it is well designed in accordance with the following guiding principles (Figure 79):

- a) It should visually relate to the façade of the building and be designed integrally with such façade. It should not project more than the underlying open or closed balcony, as the case may be and in line with the provisions in Policy P51.
- b) It should be designed in a manner that terminates the building in a visually appropriate manner.
- c) It should not appear as a weak and thin element.
- d) It should not be accessible. Opportunities to integrate landscaping within the design of the cantilever should instead be exploited



Figure 79: Roof cantilevers

5.2.5 Urban elements – trees and street furniture



Figure 80: Trees provide an important qualitative contribution to the built environment

G41

TREES AND OTHER LANDSCAPING



Any soft landscaping scheme, whether part of a new development or improvement scheme, may require tree planting.

*Trees are important urban elements that should be used to provide a natural green element and interest to an urban area. They help define open spaces, frame important buildings and vistas within or towards an urban setting, and screen unsympathetic areas that detract from the characteristics of more sensitive urban contexts. They furthermore provide an environmental asset by shading footways and urban spaces (Figure 80). Tree species that attract wildlife are encouraged in suitable locations, as are native tree species, in line with the provisions in the document **Guidelines on Trees, Shrubs and Plants for Planting & Landscaping in the Maltese Islands (MEPA, 2002)**. Details of chosen tree species should be submitted to the competent authorities as part of the development planning application.*

With regard to existing trees within urban areas, care should be exercised in the trimming and (where necessary) removal of trees, particularly within Urban Conservation Areas where such trees might be concealing or damaging important heritage buildings. Where trees merit

protection, adequate measures should be taken to reconcile the protection of the tree and the conservation of the building, whichever of the two is deemed to be most onerous. Any trimming/pruning or uprooting of trees may require the authorisation from the competent authority in line with legal requirements.

The Authority also encourages well-designed and contextually fitting landscaping proposals. The removal of any soft or hard landscape area within urban areas for development purposes is discouraged, unless an alternative landscape area is provided within the same area that in the opinion of the Authority is of a higher standard of design than the original and which, through its relocation does not reduce the value of the urban area.

Any development proposal that proposes or requires landscaping should include a landscaping scheme which is compatible with, and enhances, the character of the broader context wherein the proposal is to be located. The type of landscaping that would be appropriate depends upon the individual characteristics of the urban setting, guided by the following provisions (Figure 81):

- a) Careful consideration should be given to the purpose of the landscape. If it will be used in association with a recreational use the landscape scheme should normally comprise both hard and soft landscaping. The planting should be used to complement the streetscape and provide visual interest, whilst the hard landscaping should both complement the visual attraction of the planting and serve a functional use, for example by providing a seating area or footway. Landscaping may also be used for other purposes, such as the provision of security to a property through the use of planting. In this case the planting should contribute to the visual attractiveness of the urban setting whilst still serving its intended purpose.*
- b) Street furniture should form an integral element to any landscape scheme within a urban area, however the quantity of street furniture should be kept to the minimum necessary to serve the use for which it is intended, so as not to create visual clutter.*
- c) Landscaping should enhance rather than detract from existing views. If an important vista exists within an urban area, any planting should ensure that it does not obscure such view, for example through the selection of planting which does not grow too high or too wide.*
- d) Native plant species should normally be used, in line with the above provisions.*
- e) Paved areas should normally comprise of high quality materials, in line with the provisions in Guidance G51.*
- f) Landscaping should be used to enhance and attract people to features of architectural or historic importance, for instance through the provision of a seating area or planting around a specific architectural element.*



Figure 81: *Well-designed landscaping schemes improve the amenity value of urban areas*

G42

STREET FURNITURE



Street furniture, as defined within the Glossary of this document, makes a vital contribution to the character of an urban setting and can either detract from or enhance the value of an urban area depending on its design, location and level of maintenance (Figure 82). It is important to pay particular attention to street furniture both in new developments and in enhancement schemes.

There is no singular design typology for street furniture, since each urban area has its own character. Its design should nevertheless be guided by the following design parameters:

- a) *The street furniture design should respect the character and, if applicable, the historical legacy of the urban area, whilst serving the purpose for which it is designed.*
- b) *The street furniture should be manufactured out of high quality, durable and robust materials and follow the criteria in relation to functional considerations of materials, in line with the provisions in Guidance G48. Its colour and texture should follow the provisions in Guidance G52.*
- c) *The positioning of street furniture may have a profound impact on the appearance of an urban area and the effect of its location on the streetscape should be studied.*

Specifically:

- *it should not obscure, or compete with, any architectural features of visual value, such as scheduled properties or a vista along a specific route;*
- *it should also not obstruct the carriageway or footway, unless that is its purpose as part of an approved traffic calming scheme; and*
- *where seating areas are provided, a proportion of the seats should be located in a shaded position, such as beneath a tree or within the shade of a building.*

Scheduled street furniture should be kept in use and integrated in any new design, if possible. It should be kept in a good state of conservation by regular maintenance and where deteriorated or damaged it should be restored, as opposed to being altered or replaced.

Street furniture also includes plaques and monuments; the former including both commemorative plaques, which are usually formal memorials, and interpretation panels, which are usually lightweight structures and intended for didactic purposes. In the installation of commemorative plaques and monuments extra care should be taken to minimise any potential damage to the building fabric and should be sensitively positioned to enhance the character of the urban area or building (Figure 83).



Figure 82: Street furniture enriches the quality of urban spaces through its visual, functional and social contributions



Figure 83: An interpretation panel (bottom left) and commemorative plaques (top left, right)

5.3 OPENINGS

5.3.1 General design principles for building openings

G43

OPENINGS – GENERAL DESIGN PRINCIPLES



The design of openings within a building façade may have a significant impact on the appearance and character of that building, as well as on the neighbouring buildings that compose the entire streetscape.

For this reason they should be well-designed and relate well to both the entire building façade wherein they are located and the openings within the surrounding context, in terms of their (Figure 84):

- a) *positioning – in relation to visual, amenity (privacy, safety and security) and environmental implications, the latter also in terms of the chosen glazing technology;*
- b) *orientation – whether vertical or horizontal;*
- c) *rhythm and organisation – including frequency of openings and whether their organisation (in their totality) happens in vertical or horizontal bands; and*
- d) *proportion and sizing – in relation to amenity, environmental and visual (solid:void ratio) implications.*

These characteristics vary depending on the nature of the specific context.

For instance tightly knit urban areas, such as older village cores and Urban Conservation Areas, tend to be characterised by some or all of the following qualities: (a) symmetrical positioning of (b) vertically-oriented openings, (c) organised in clearly defined horizontal bands and having a regular, quick rhythm (particularly on narrow-frontage buildings) (d) of narrow opening widths that produces façades with a high solid:void ratio (Figure 85).

While it is not the scope of this document to prescribe specific quantitative parameters for the above-listed characteristics, on-site observations as part of the streetscape analysis discussed in Part 1 of this document should nonetheless establish the salient aspects in relation to the above qualities, which should in turn broadly guide the design of new openings. Thus, in the above-mentioned example for tightly knit urban areas, it would be undesirable to have large horizontally-oriented openings that are undefined along the façade, and that contribute to a low solid:void ratio on such façade (Figure 86).

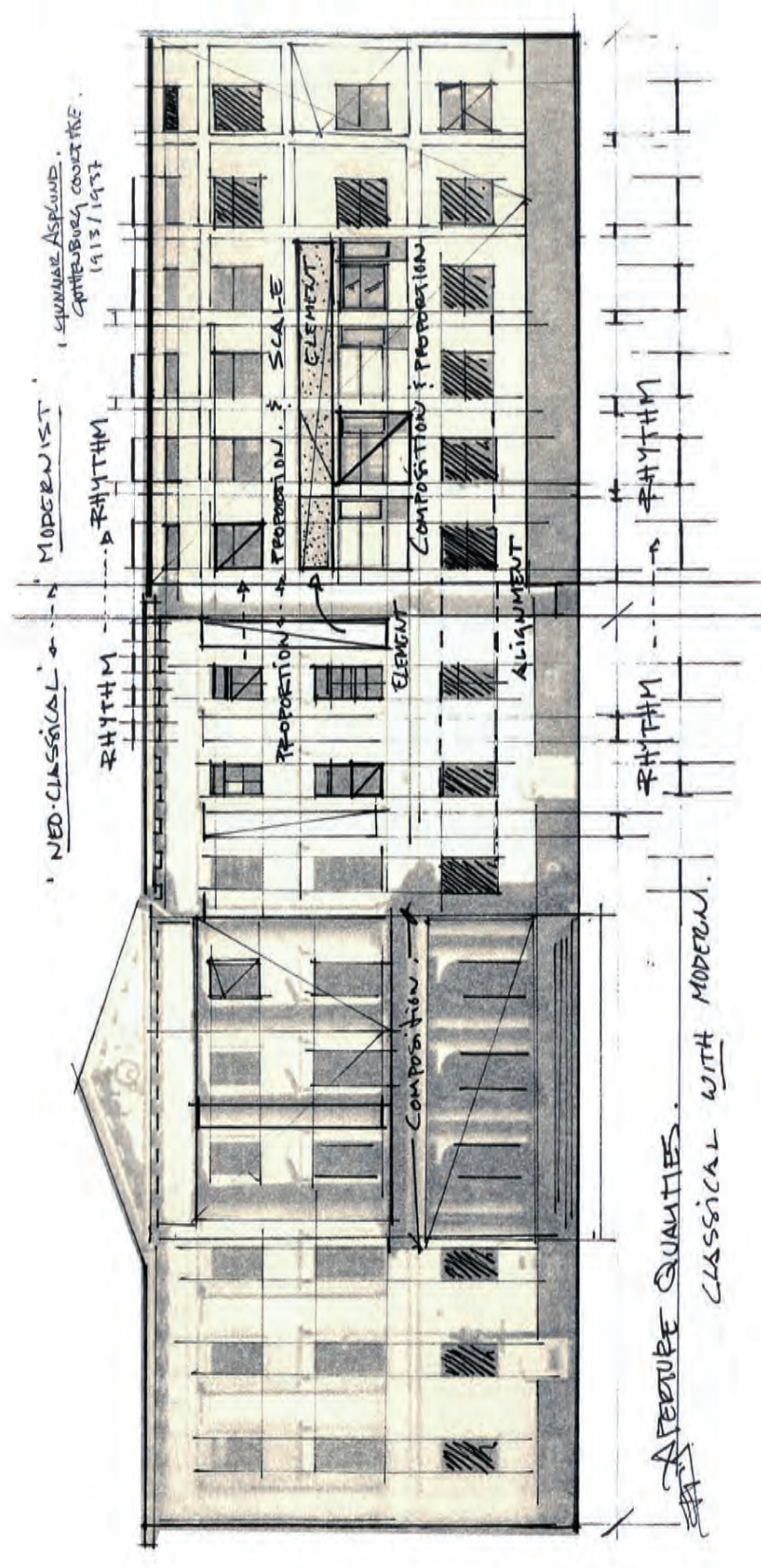

Figure 84: Key design considerations for openings include their positioning, orientation, rhythm/organisation and proportion/sizing



Figure 85: *Openings located on buildings within older village cores are typically characterised by symmetrically positioned vertical openings organised in horizontal bands and a high solid: void ratio*



Figure 86: *The sense of solidity characterising tight-knit urban areas is also due to a high solid: void ratio*

5.3.2 Design of apertures on façades

G44

DESIGN OF APERTURES ON FAÇADES



Outward opening windows and doors, and projecting solid features may prove hazardous to pedestrians (where they would open or project over a public pavement) or to vehicles (where they would open or project over a public street).

All windows, the lower edge of which is less than 2 metres above pavement level, and doors should be so designed and fitted that they do not open outwards onto a public pavement. Where there is no pavement, windows and doors shall not open outwards directly over a public street or other public space used by vehicles. The Authority may make an exception for emergency exit (fire) doors in public buildings, if such doors will not be used frequently.

Furthermore, where window grilles (including 'pregnant' windows), sills, planters and other elements which are part of, or fixed to the façade of, buildings are less than 2 metres above pavement/street level, they should not project more than 0.15 metres from the façade over a public pavement or street (Figure 87).

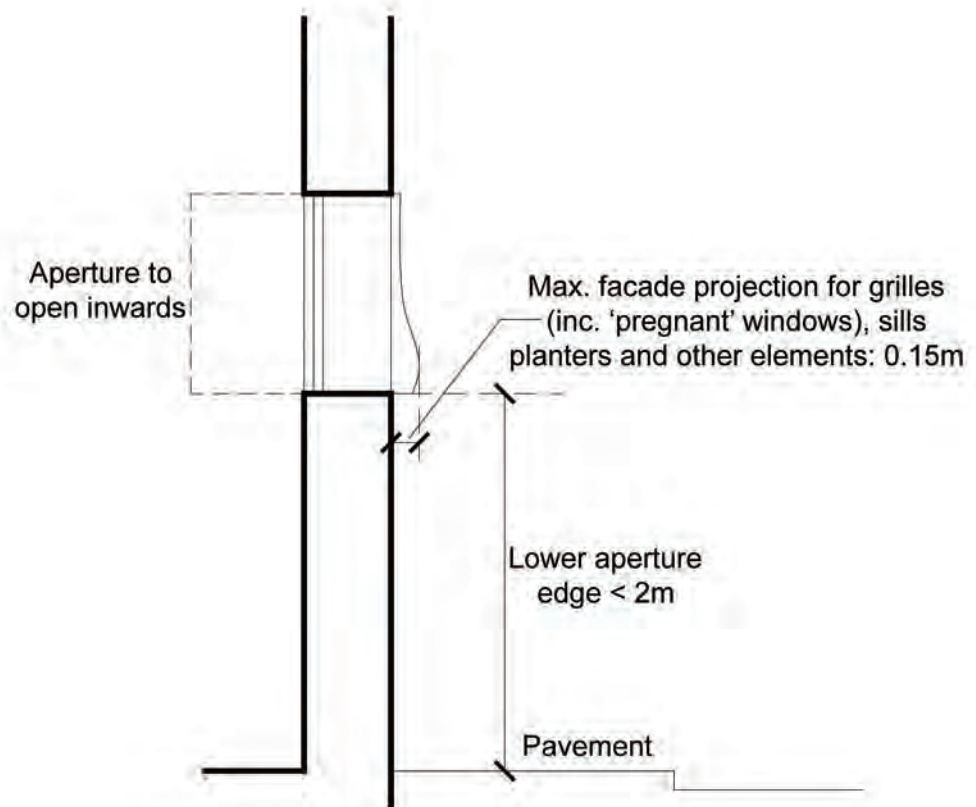

Figure 87: Key quantitative criteria for apertures on façades

5.3.3 The design of apertures in shop fronts

G45

APERTURES IN SHOP FRONTS



The proportions and detailing of a shop window have an immediate impact on the street scene and should therefore be given careful consideration (Figure 88).

Where possible, traditional or original shop windows of character, as well as existing original doors, should be retained and renovated in heritage buildings, particularly scheduled properties and properties within Urban Conservation Areas. New openings or widening of existing openings would not normally be allowed on these buildings.

The design of new shop front apertures should be guided by the following design parameters:

- a) *New shop windows should reflect the vertical emphasis of building apertures, in line with the provisions in Guidance G43. Mullions or transoms may be required to break up large expanses of glass, where this is appropriate.*
- b) *The design of the main door should also reflect the design of other apertures, namely the shop front and any windows.*
- c) *The materials for these apertures are to follow the provisions in Guidance G50.*

The shop entrance is important in creating a welcoming impression to the shop. Indeed, recessed doorways are a traditional feature of late 19th and early 20th century shop fronts and help to draw passing trade into the shop. In visual terms, a recessed doorway further creates interest and relief in the frontage and may help to break down the scale of the façade. The entrance should be accessible to all, in line with the provisions in Policy P11.



Figure 88: Well-designed and proportioned shop front apertures

5.4 BALCONIES

5.4.1 General design principles for balconies



Figure 89: Valletta is characterised by the interesting rhythm provided by both open and closed balconies

G46

BALCONIES – GENERAL DESIGN PRINCIPLES



Balconies may be a useful amenity and an important design feature on building façades. If well designed, they may add interest and variety to the appearance of a building, in line with the following guiding design principles (Figure 89):

- a) The design, form, proportions and materials of a balcony should relate to the overall architectural design and details used on the façade of the building of which it forms a part, and should be respectful to the context within which the building is situated, in accordance with the area's urban design characteristics.
- b) When corbels are used they should be in proportion with the depth of projection of the balcony, both in height and in width.
- c) A balcony should be at a minimum height of 2.75 metres measured from the finished pavement level to the underside of the balcony in order to guarantee both pedestrian and vehicular safety.
- d) A balcony should be located so that its outer face side is at least 0.75 metres away from the inner face of the party wall nearest to such balcony, thus minimising potential amenity issues that may be detrimental to such property.
- e) Where desirable, balcony railings should have a vertical orientation in order to ensure safety.

In Grade 1, Grade 2* and Grade 2 buildings, stone, wooden and wrought iron closed or open balconies should be kept in a good state of conservation by regular maintenance and, where deteriorated or damaged, they should be restored rather than altered or replaced. If, in the opinion of the Authority, a balcony is confirmed to be so dilapidated that it may not be reasonably maintained, a replacement would be permitted provided that it conforms to the original design and fully respects the proportions, details, materials and colour of the original aperture. The replacement of parts or all of the original balcony, utilising non-traditional building materials, would not be acceptable since this would rescind the quality of the original façade of the building and the streetscape. Furthermore, permission would not normally be given for the enclosure of open balconies if the latter form a series of similar others along the street, thus providing a strong rhythm to the streetscape.

In Grade 3 buildings or lower, the retention, maintenance and restoration of stone, wooden or wrought iron closed or open balconies would be encouraged, although replacement may be considered in the following exclusive circumstances:

*The balcony would not be part of a series of similar balconies on adjacent buildings; and
The balcony would not be in a state of being properly maintained or repaired.*

Balcony replacements should be similar to the original design, proportions and colours and preferably be constructed in the same material as the original. If an alternative material is to be used, the replacement should nevertheless be sensitively designed in a similar manner to the original balcony and/or similar surrounding elements.

Further guidance regarding the materials of balconies is provided in Guidance G50.

5.4.2 Balcony projections

P51

BALCONY PROJECTIONS



Great care will be taken as to balcony projections in relation to the existing street width, especially where there is no front garden and/or pavement. The presence of existing balconies within the street will also be an important consideration.

For this reason, no projection will be allowed on the façade of the building if the resulting clear width of the existing street (measured between balcony projections) will be less than 4.1 metres.

The maximum allowable projection will vary depending on whether the balcony is open or closed.

Open balconies

The maximum projection of 1.5 metres from the façade will only be allowed where there is a 3-metre front garden (Figure 90a) or a pavement having a width of 2.5 metres. For front gardens that have a width of 'x' metres that is less than 3 metres, the maximum balcony projection will be worked out at a relative ratio of $x/3$. Where there is no front garden or the pavement has a width of less than 2.5 metres, the maximum projection will not exceed 1 metre (Figure 90b). Within Urban Conservation Areas, the maximum projection shall not exceed 0.75 metres.

Closed balconies

Closed balconies shall not project more than 0.6 metres from the façade when there is no front garden, and 1 metre from the façade when there is a 3-metre front garden (Figure 91).

In both open and closed balconies, corbels or any other overhanging elements are not to exceed a depth of one course.

Furthermore, in order to safeguard the amenity of adjoining properties, a balcony on the side and back elevations of a semi-detached or detached dwelling will only be permitted where the curtilage is wide enough so that the front edge of the balcony is at least 3 metres away from the property boundary line (Figure 92).

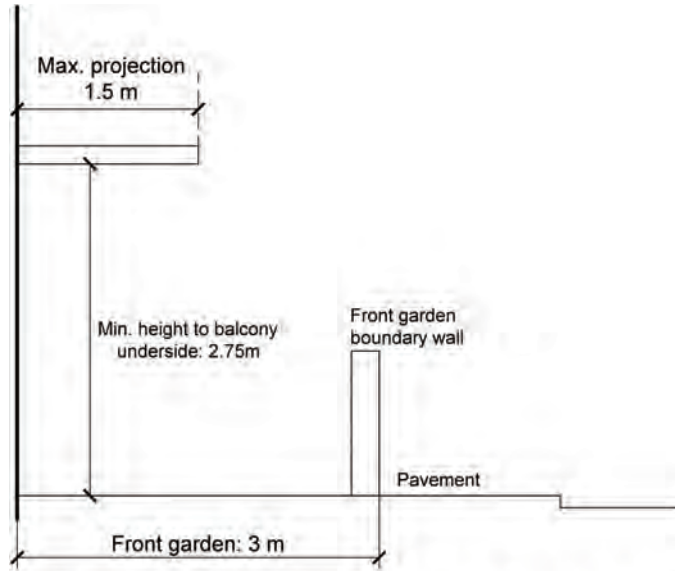

(a) Open balcony projection with front garden

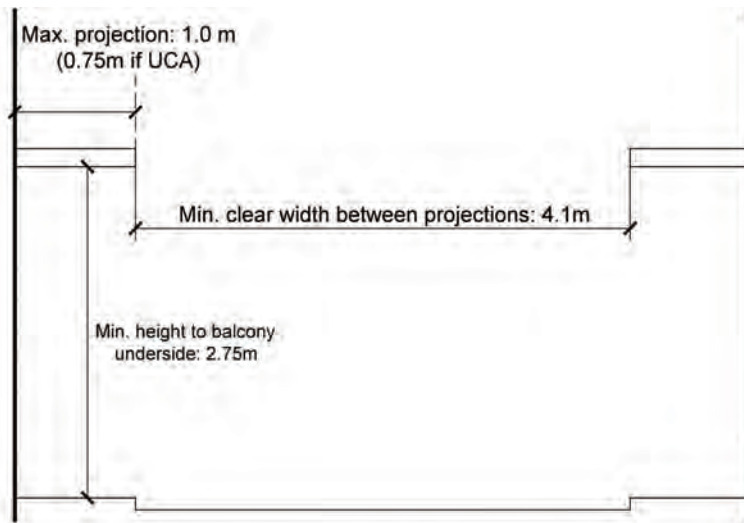

(b) Open balcony projection with no front garden

Figure 90: Open balcony projection for existing streets

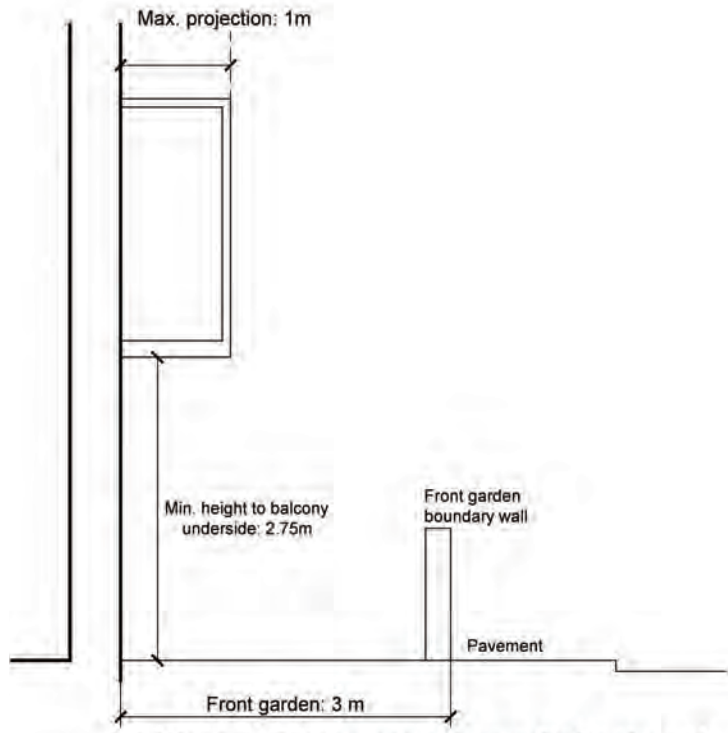

(a) Closed balcony projection with front garden

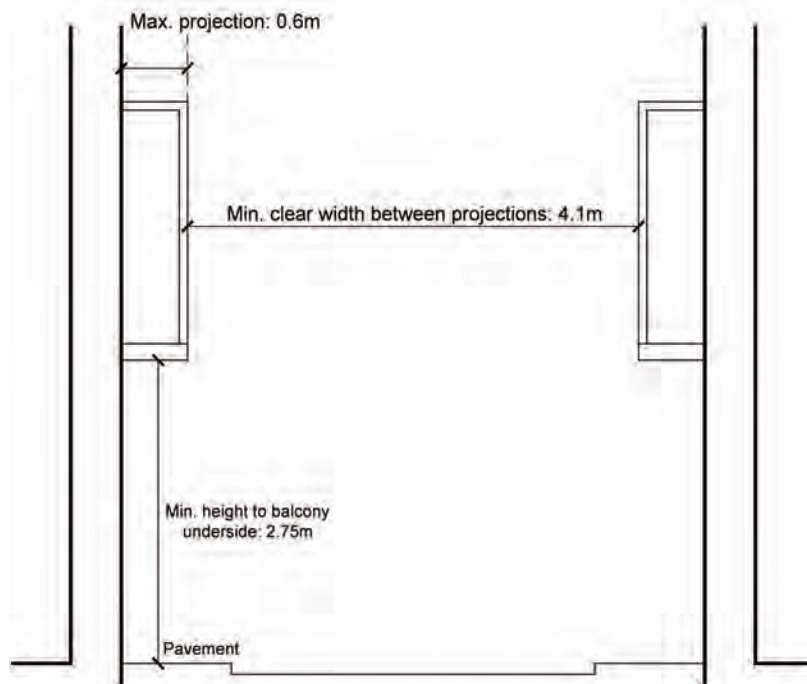

(b) Closed balcony projection with no front garden

Figure 91: Closed balcony projection for existing streets

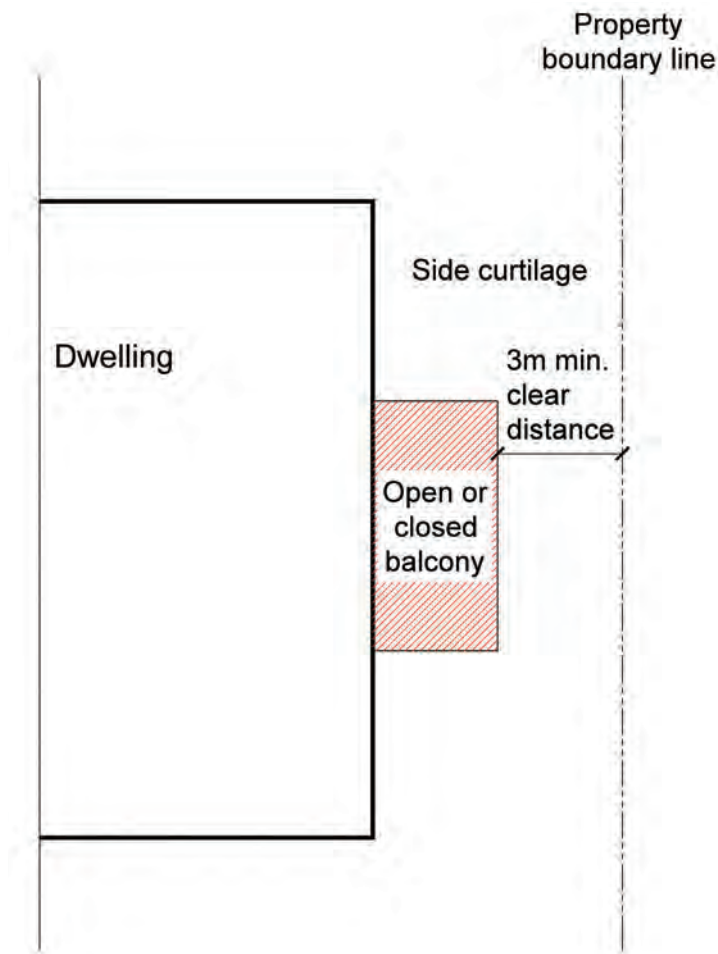

Figure 92: Maximum balcony projection over side curtilage

5.5 SERVICES

5.5.1 General design principles for services

P52 DESIGNING FOR SERVICES



Buildings, of both residential and non-residential nature, are required to cater for a myriad of services, including water tanks, satellite dishes, air conditioners, standby generators, SWH collectors and PV modules. The majority of these services have traditionally occupied the roof level of a building. The lack of proper attention to the design of building services can be detrimental to roofscapes, the visual clutter therein resulting in significant implications to both the urban skyline and the building roofline within a street (Figure 93).

Building services will be required to:

- a) *Be designed integrally with the rest of the building.*

With the exception of SWH collectors and PV modules, in line with the provisions in Policy P48, no services will be allowed on the front elevation of a building or any elevation of the building which is visible from a public space. The building services in question include drainpipes; pipes attached to air-conditioning units; flues and/or extractors; and external cables in connection with the provision of telephony and electricity services. Provision for concealing these services should be made in the design of the building façade. At the very least, the design must ensure that unsightly features are properly screened, in line with the provisions in Guidance G47.

- b) *Wherever possible, be located internally within a purpose-built plant room (especially in medium- to large-scale developments) or most conveniently located service space.*

Specifically:

- (i) Water tanks may be placed internally, which may subsequently give rise to more innovative architectural solutions in the way that the buildings are capped (Figure 94).*
- (ii) In the case of SWH collectors and PV modules that need to be mounted externally at roof level, the design should follow the provisions of Policy P48, although the SWH tanks may be placed internally.*

In the design of new developments, the allowable building height as established in the Local Plans is to include all building services, in line with the provisions of Policy P35.

Furthermore, in the design of medium- to large-scale developments and redevelopments, significant opportunity exists to relocate services underground as opposed to having them exposed on building façades, in line with the provisions in Guidance G29.



Figure 93: *Visual clutter on roofscapes due to the sporadic location of services*

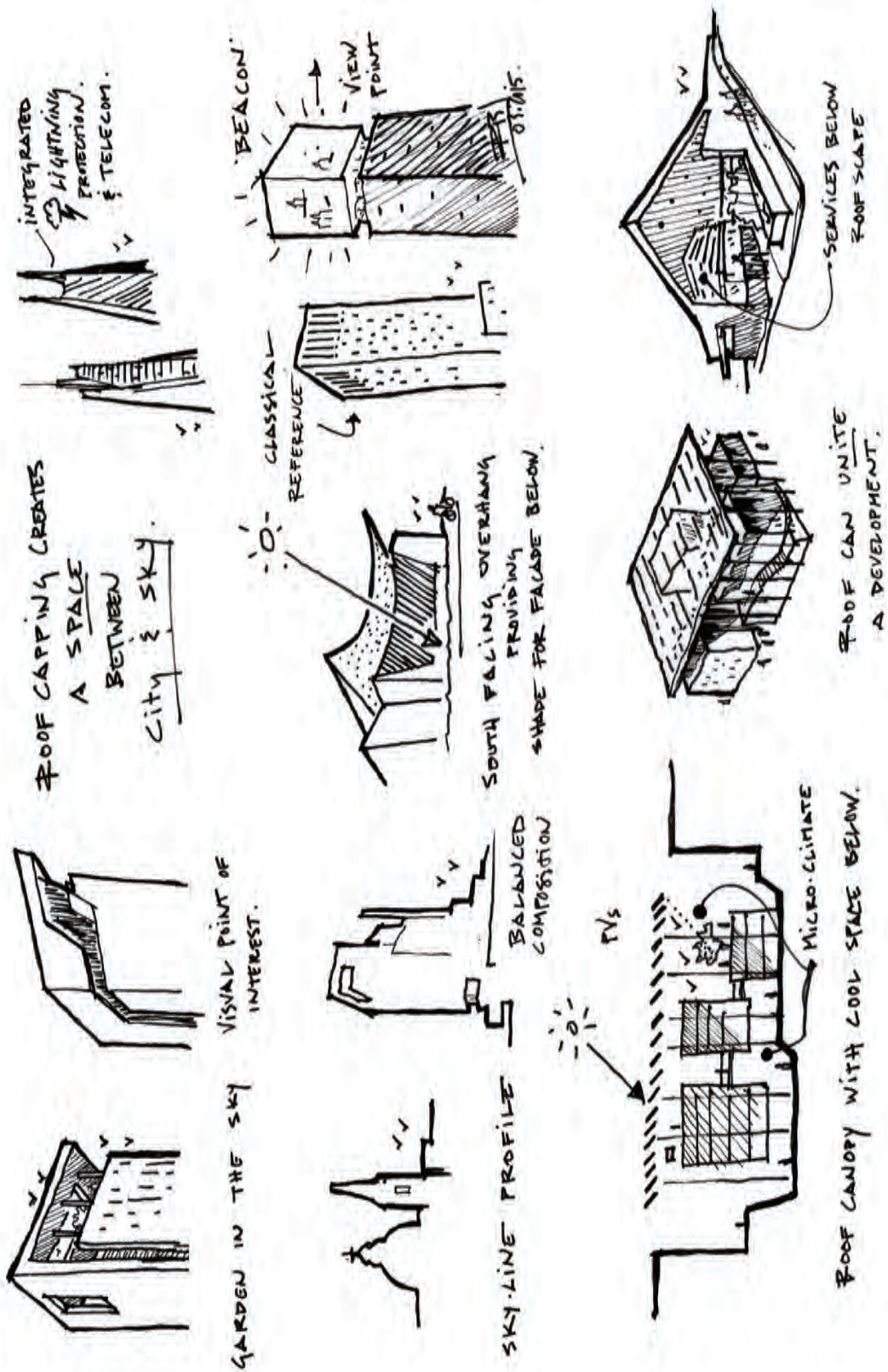

Figure 94: Opportunity exists to design the roof capping in innovative ways

5.5.2 Chimneys/flues and fume extraction

This policy is an interim policy pending the approval of the Building Regulations.

P53

CHIMNEYS / FLUES, FUME EXTRACTION



In the design of chimneys or flues the main objective will be to limit the potential negative impacts that could be caused through the emission of smoke or fumes as well as the visual impact, particularly to neighbouring developments.

For this reason, the following provisions will apply for chimneys and flues – chimneys serving fireplaces that may be allowed on the roofs of residential developments and flues utilised in non-residential developments:

- a) *the height of the chimney/flue will be 3 metres above the highest roof of any building within a radius of 25 metres;*
- b) *the chimney/flue shall not be so located or positioned on the roof of a building that it terminates within 4 metres of the windows of any residential property overlooking or adjoining the roof;*
- c) *in new developments, the chimney/flue will be set back from the façade at least in line with the setback of the topmost floor in line with Policy P39; and*
- d) *the design, location, dimensions, materials and colour of the chimney/flue will be appropriate to the building and to its broader context in such a manner that it does not detract from either the building's appearance or the area's visual quality.*

The above provisions also apply in the case of chimneys and flues on buildings located Outside Development Zone.

Commercial kitchen extract systems

Given the greater concern of the implications for flues and fume extraction in the case of cooking smells from restaurants, cafés, snack bars, take-aways and the like, and even more so where these uses are located under or adjoining dwellings, in addition to the above provisions the following considerations will also be taken on board in the design of commercial kitchen extract systems:

- 1) *Filtered or unfiltered kitchen extract points will not discharge to, or terminate in a shaft, yard or any elevation which serves residential properties. The height of the flue will be 3 metres above the highest roof of any building within a radius of 25 metres.*
- 2) *The Authority shall require a report by a Warranted Mechanical Engineer, which shall recommend appropriate type of odour filtration equipment, based on a case-by-case risk assessment method.*

Such a recommendation of type of filters and risk assessment shall be carried out in accordance to internationally available guidance documents. The type of odour filtering equipment shall always be based on a risk assessment that considers the worst-case scenario of cooking type and discharge velocity.

The Authority will alternatively accept the use of filters that do not require external venting. Nevertheless, the use of such unvented kitchen extraction is to be accompanied by a design of a ventless system designed by a Warranted Mechanical Engineer in accordance

to international guidelines. Such a system will also take into account whether the cooking ranges from where the extract hood is extracting are based on electrical or gas-fired appliances.

Control on the environmental effects of the development and its operation will also be operated through the (separate but related) environmental permitting process.

5.5.3 Design for the integration and screening of services

G47

THE INTEGRATION AND SCREENING OF SERVICES



Some building services may not be located internally within designated plant or service rooms/spaces and may need to be placed on the roof of developments, within balconies or on the façades of buildings; namely:

1. Satellite dishes up to 1.2 metres in diameter that are placed on the roof.
2. Air-conditioning outdoor units/VRV units that must be placed (a) on the roof; (b) within (front, side and/or back) outdoor balconies; (c) within the design of shop fronts; or (d) directly on the façade if the property does not have access to a yard (internal or back) or own any roof space or balcony.
3. Water tanks that can only be placed on the roof, due to restrictions with the building's configuration and/or internal layout; as may be the case with heritage buildings (particularly scheduled properties and properties within Urban Conservation Areas) that may not be modified.

Besides the potential visual impact of exposed building services, some services (notably A/C and VRV units) may give rise to nuisance through humming noise, particularly at night, and should therefore not be sited where they would raise the ambient noise level at night in adjoining bedrooms of dwellings. The following provisions are to guide the design considerations for the above building services:

- a) They should be located in a manner that is least likely to result in negative impact from nearby streets or from adjoining buildings.

Air conditioning units should normally not be located on the façades of buildings unless they are:

- designed as an integral part of the building, incorporated into the building fabric, for instance through the use of recesses, in which the units are located and screened by architectural elements; or
- screened, in line with the provisions for screening below.

In such cases permission may be given for the location of such units on balconies or within the design of a shop front, where this would not adversely affect the external appearance of the building.

- b) At roof level, they should not exceed the height limitation as established in the Local Plans and should furthermore be placed as a cluster.

Screening

In order to avoid visual intrusion and/or clutter, and so as to integrate them better within the built fabric, these services should be screened. The design of screening devices should be studied in relation to the rest of the building and should be integrated into the building's

overall design in terms of both material and colour, especially if deployed on the façade of buildings.

Such screen is to be non-solid (louvered), made of suitable materials such as painted timber, coloured metal (steel or aluminium) or plastic (UPVC) (Figure 95), although a stone screen might offer a better solution as it would blend in more with the surrounding context. If located at roof level, it should not exceed the allowable height limitation as established in the Local Plans (Figure 96 illustrates some possible scenarios; see Figure 65a for the screening of inclined PV modules or SWH collectors).

For all buildings, the placing of commercial generators, chillers or any other bulky equipment on the roof of washrooms, penthouse or any other part of the roofs would not be allowed.

- BEFORE -

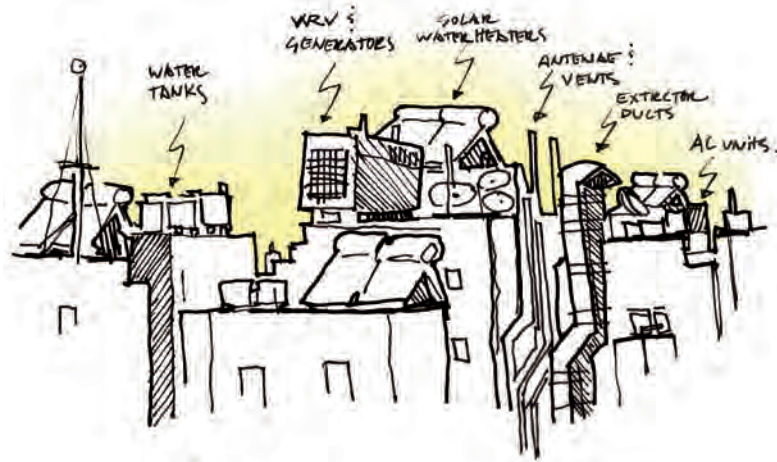

HAPHAZARD SKYLINE
RANDOM ROOF SERVICES CLUTTER
HORIZON

- AFTER -



HARMONIOUS SKYLINE
PLEASANT ROOFSCAPE WITH INTEGRATED
SERVICES & INITIATIVES.

Figure 95: Screening of services at roof level

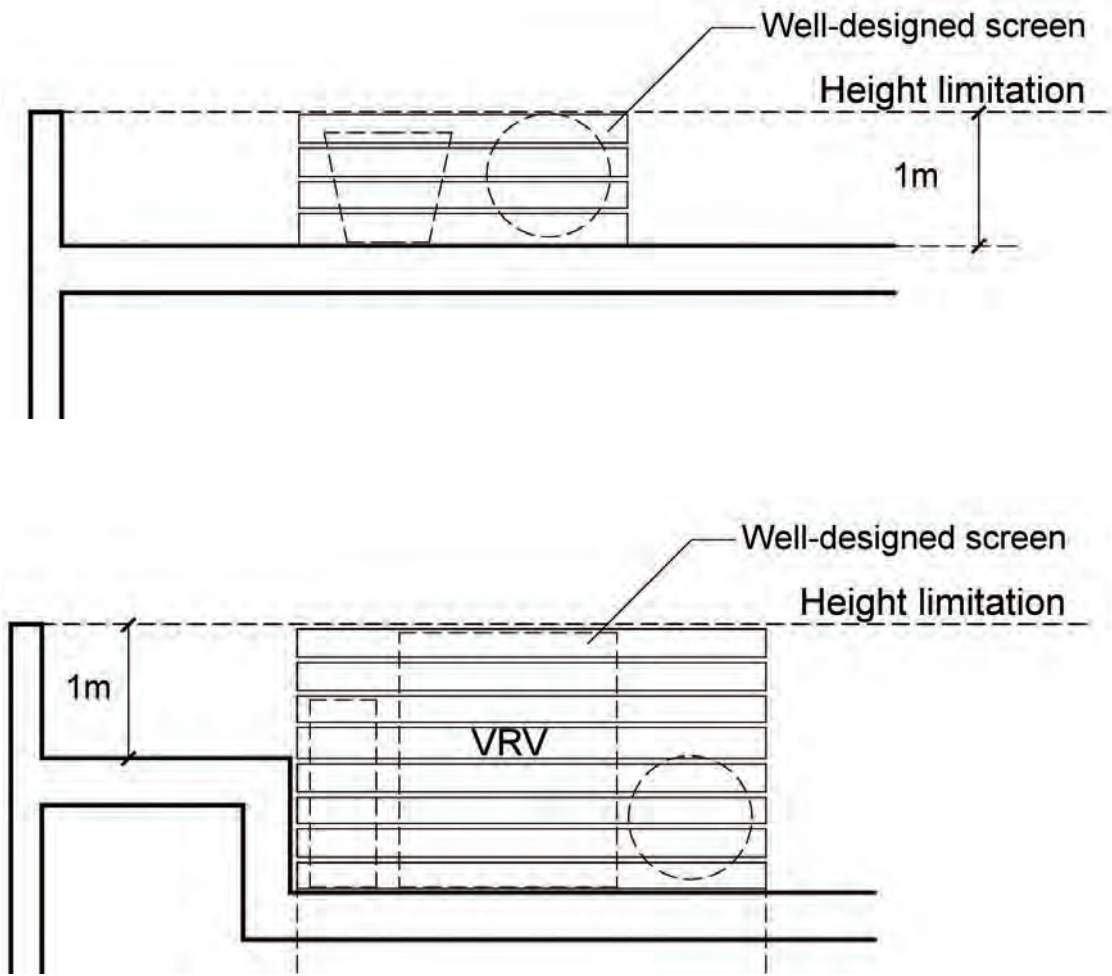

Figure 96: Services located at roof level – different possible scenarios with screening requirements

5.6 MATERIALS AND FINISHES

5.6.1 General design principles for materials

G48

MATERIALS – GENERAL DESIGN PRINCIPLES



Materials used within new developments or redevelopments should be fit for purpose, in visual, functional, environmental and perceptual/sensorial terms, as guided by the following important principles (Figure 97):

- a) *Visual* – materials should be appropriate to the surrounding location and context, particularly the immediate streetscape wherein the development is located. The materials of apertures on buildings located in sensitive environmental or historical locations, such as ridges and Urban Conservation Areas respectively are even more critical, as discussed in Guidance G50.
- b) *Functional* – chosen materials should be suitable for their intended function, which directly relates to issues of their serviceability and detailing. They should also be able to be cleaned, maintained and/or (if necessary) replaced with ease.
- c) *Environmental* – in terms of the lifetime of chosen materials and their sustainability, which results from their intrinsic physical properties, as well as the possibility of reusing/recycling materials in order to reduce waste generation.
- d) *Perceptual/sensorial* – opportunities for different sensory experiences through the utilisation of different material textures should be exploited.



Figure 97: Choosing a good material palette comprises an important stage in the design of a development

Source: (right) Kurt Arrigo Photography

5.6.2 Materials for building exteriors, elements, apertures and balconies

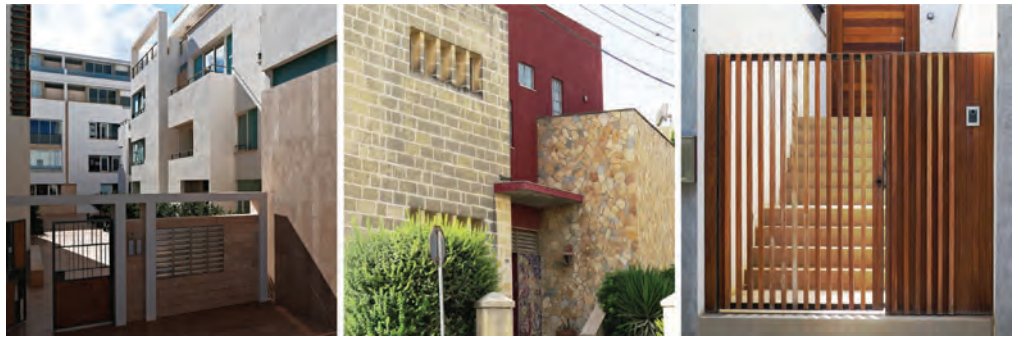

Figure 98: Interesting use of materials within the urban fabric
Source: (left) Kurt Arrigo Photography

G49

MATERIALS FOR BUILDING EXTERIORS



In order to achieve the visual considerations for the design of materials identified in Guidance G48, the Authority encourages the following aspects with regard to materials deployed on the exterior of buildings (Figure 98):

- a) The materials used should add interest and variety to the townscape qualities of an area, and not detract from its character.
- b) In order to be appropriate to their context, the design of materials should give due regard to issues of form, proportion and colour.
- c) Creative and innovative ways of using local stone should primarily be considered, particularly in small-scale developments where the scale of the stone as a building block may have greater relevance and impact.
- d) In heritage buildings, particularly scheduled properties and properties within Urban Conservation Areas, the use of unrendered local stone for building exteriors is preferred, unless the context indicates otherwise, such as: the rendering or painting of ground floor façades and new extensions at the back of the property (Figure 99). Façades should not be hacked or grit blasted.
- e) Proprietary external plasters that give a fine finish should be used for rendered building finishes, rather than the application of graffiato finish. The Authority will also encourage the innovative use of cladding materials and the design of ventilated façades, and the incorporation of proprietary external insulation and finish systems.
- f) Imported architectural elements and materials, such as ‘terracotta’ tegole, may be acceptable in specific locations; however, these should be used with care and sensitivity to the surroundings and be limited to small features. They would not be allowed on external façades in Urban Conservation Areas or scheduled properties.

In line with the provisions in Guidance G29 the use of more contemporary materials may be more appropriate in medium- and large-scale developments, particularly commercial and industrial developments located in Area Typology A4b (Figure 100).



Figure 99: Building exteriors in Urban Conservation Areas



Figure 100: Contemporary materials deployed within medium-scale developments

Source: (left) Kurt Arrigo Photography

G50

MATERIALS FOR APERTURES, BALCONIES AND ELEMENTS



In order to achieve the visual considerations for the design of building materials identified in Guidance G48 (Figure 101):

- a) *The materials used in apertures and balconies should relate to those used for the remainder of the building, although it may also be appropriate to use different materials in order to provide variety and interest. Their use should, however, not be incongruous or lead to a lack of unity or cohesiveness in the building's appearance, and neither should they disrupt the harmony of the wider townscape.*
- b) *In new developments, redevelopments, alterations and/or extensions, the Authority favours the use of non-metallic finished aluminium-, brushed steel- and UPVC-framed apertures and balconies.*

- c) *In the case of alterations and extensions to existing buildings, the Authority would only permit the use of gold, silver or bronze aluminium for apertures or balconies if they would be in keeping with the materials predominantly used elsewhere in the same façade of the building.*

In line with the provisions in Guidance G29 the use of more contemporary materials may be more appropriate in medium- and large-scale developments, particularly commercial and industrial developments located in Area Typology A4b. Great care should nonetheless be taken to ensure that the deployment of glazing, especially if occupying a large area, gives due consideration to:

- *building orientation;*
- *undue sunlight reflection;*
- *excessive heat gain;*
- *glass colour, since large areas of dark glass tend to read visually as a hole and may give a building an unwelcoming appearance; and*
- *glass typology, such as mirror glass that reflects its surroundings and that might not be appropriate in areas characterised predominantly by traditional materials.*

In environmentally sensitive locations, such as ridges, and within Urban Conservation Areas the use of materials is to be guided as follows (Figure 102):

The use of traditional materials and finishes is favoured; such as wood treated and painted in a traditional colour for apertures and balconies and painted wrought iron for the railings of open balconies and for security grilles of apertures. The decision to deploy specific materials should arise out of both the street categorisation and building grade, as well as out of the context analysis that is carried out at the onset of the design process. Irrespective of street categorisation, however, the merits of the individual buildings should be assessed in terms of their specific (a) architecture and (b) massing. The materials of elements should relate to these intrinsic qualities and should not be simply applied blindly. Alternatives to traditional materials may be more suitable, such as UPVC- and aluminium-framed apertures.

Ultimately, the appropriate design of an aperture does not solely depend on its material but, more importantly to the issues outlined in Guidance G43. As a means of illustration, one may find a well-designed aperture constructed in non-traditional materials as well as badly designed aperture constructed in traditional materials such as wood.



Figure 101: An interesting use of materials for different aperture typologies



Figure 102: Aperture materials within Urban Conservation Areas demand an in-depth study

5.6.3 Materials for external paved surfaces

G51

MATERIALS FOR EXTERNAL PAVED SURFACES



The nature of external paved surfaces around buildings (public amenity, access and circulation spaces) contributes towards the general quality and attractiveness of urban spaces and provides a vital contribution to the character of an urban setting, particularly in Urban Conservation Areas. Materials used for such surfaces should be:

- a) *durable and safe to use, and should not become slippery when wet; and*
- b) *of an appropriate colour, form and texture which do not detract from the character or townscape qualities of the area (Figure 103).*

In Urban Conservation Areas, the Authority encourages the use of surfacing materials that are sympathetic in texture and colour to the character of the surrounding context. Traditional surfaces should be retained or reintroduced where there is historical evidence for them. Furthermore, if a street is to be pedestrianised, it is important to retain the traditional relationship between footways and carriageway, including kerblines.

The role of materials in providing a more amenable and accessible environment for all should be a central consideration in the design of external areas, specifically with regard to the provision of different tactile surfaces for visually impaired users in order to denote level changes or to signal specific areas such as pedestrian crossings.



Figure 103: *The use of high-quality materials in the paving of external environments is of utmost importance*

5.7 COLOUR



Note: Applicable to UCAs and Scheduled Buildings in all areas. Data collected from inspections related to Wooden Balcony Grant Schemes.

Figure 104: Heritage Buildings Traditional Colour Palette

G52

DESIGNING FOR COLOUR



As one of the final elements applied to external finishes of a building and its components, colour plays a significant role in the overall external appearance of a building and actively contributes to the visual and experiential qualities of the broader urban environment wherein such building is located, with streetscape and townscape implications. These implications may be experienced both in the short-range (as with the case of a street) and in the medium- and long-range (as with seafront developments, buildings on ridges and/or medium- and high-rise developments).

When deciding about the colour scheme for a development, regard should be given to the existing colour palette within the surrounding context, assessed through an analysis according to the provisions of Policy P1. As a general guideline, however, building colours should be limited to natural earth or pastel tones, with specific building elements having complementing darker hues of the same colours, monochrome hues, or primary tones that could also contrast the main façade colours. In Urban Conservation Areas and scheduled buildings, traditional primary colours (such as dark green, navy blue and dark red) should be used wherever possible for openings (Figure 104). The overall colour scheme should nonetheless be harmonious, and contribute to unifying different building elements together. Fluorescent colours should therefore not be deployed within any colour scheme (Figure 105).

With regard to the colour of street furniture, a balance needs to be struck between respecting the character of the urban area and being visually appropriate, particularly with regard to vulnerable users. For instance, although a brightly coloured litterbin would detract

from the visual cohesiveness of an area, one that blends in too well with the background (say, a green litter bin next to green vegetation) might cause a hazard to visually impaired pedestrians. A compromise might be a dark blue litterbin that would be easily identifiable and generally not detract from most contexts.

In line with the provisions in Guidance G29 the deployment of colour should not be as onerous in medium- and large-scale developments, particularly commercial and industrial developments located in Area Typology A4b wherein the urban context may permit a greater variety of colour schemes.



Figure 105: *Interesting (left) and undesirable (right) illustrations of colour deployment within the urban fabric*

5.8 ARCHITECTURAL ELEMENTS – QUALITY CHECKLIST FOR *PERITI*, ASSESSORS AND DECISION-MAKERS

Interpretation of, and alterations to, existing architectural elements and features

- Is it desirable to retain, repeat or interpret existing architectural elements and features present within the building façade or on neighbouring properties? How does this decision relate to Local Plan provisions in terms of the area's designation (such as street categorisation)?
- Is the design composition well balanced and appropriate in terms of the different architectural elements?
- Is the interpretation of architectural elements and features respectful of the surrounding context and does it furthermore provide a valid contemporary contribution to the streetscape?
- Is it desirable to go for an entirely different contemporary architectural solution and will such solution be more appropriate to the street?
- What degree of alteration is acceptable to existing architectural elements and features present on buildings in Urban Conservation Areas?

Secondary elements

- Does the design, siting, form character and detail (including materials and colour) of secondary elements complement, and enhance, the architectural quality of the building and the overall character of the surrounding context?
- Is an open staircase required to resolve specific design issues and has it been designed in an integral manner with the rest of the building?
- Does the open staircase complement the building wherein it is incorporated and does it make efficient use of space without compromising the open nature of the building, particularly the front garden?
- Is it acceptable to integrate fixed structures, demountable structures and/or awnings within the development?
- Have the quantitative and qualitative parameters for fixed structures, demountable structures and/or awnings been adhered to and does the design of these elements complement the overall architectural design of the entire development?
- Do the individual shop front elements work together in an integral manner and are they respectful of the context wherein they are located?
- Have the quantitative and qualitative considerations been equally considered in the design of shop front fascias, illumination, projecting and hanging signs and security shutters?
- Is it desirable to retain or replace existing shop front elements?
- Where new shop front elements are proposed, have they been introduced in a sensitive and cohesive manner?
- Have specific considerations for shop front elements been taken into account on heritage buildings, particularly scheduled properties and properties within Urban Conservation Areas?
- Will the introduction of a roof cantilever be a positive contribution to the building façade or is it more desirable to terminate the building with a solid parapet wall?
- Does the design of the roof cantilever complement the building and the streetscape wherein it is located? Does its incorporation give rise to further design opportunities that will visually enhance the façade further?

Openings

- Do the development openings produce a cohesive building façade and are they well designed in terms of their position, orientation, rhythm and organisation, and proportion and sizing?
- Where applicable, does the design of openings utilise traditional details and finishes that enhance the building and the character of its context?
- Are the location, projection and opening mechanism of the openings respectful of pedestrians and vehicular users?
- Does the shop front aperture complement the streetscape and other ground floor façades present within the street? Specifically, have large expanses of glass been handled well?
- Does the shop front aperture complement the pedestrian activity therein and does it contribute positively to the shopping experience?

Balconies

- Does the design, form, proportions and materials of balconies complement the architectural design of the rest of the building façade?
- Do the open and/or closed balconies located on the façade of buildings respect quantitative and qualitative parameters, particularly in terms of projection and the amenity of neighbouring properties? Will the balcony projection compromise in any way the safety of pedestrians and vehicular users?
- Is it desirable to retain existing balconies present on buildings, particularly heritage buildings, including scheduled properties and properties within Urban Conservation Areas?
- Is the replacement of balconies on existing buildings respectful of the architectural design of the rest of the building and does it complement, and enhance, the streetscape wherein it is located?

Services

- Has due regard been given to the design of services in the architectural design of the entire development and are such services catered for in a comprehensive manner?
- Has particular attention been given to the roofscape in the design of services and, if possible, have services been removed from the roof level and located internally?
- Does the integration of services (or their removal) allow for more innovative roofscape design?
- Is the chimney/flue fit for purpose and does it provide adequate extraction?
- Does the design of the chimney/flue complement the roof, building and context wherein it is incorporated, in terms of scale, form, siting, character, materials, colour and detail?
- Has care been taken to mitigate any potential nuisance to neighbouring properties in terms of the chimney/flue's visual impact and fume/smell generation?
- If possible, are unsightly elements and services located out of sight or have they been adequately screened from view so as to mitigate their visual impact? Have visual implications in the short-, medium- and long-range been studied?
- Is the screening of building services on roofs, within balconies and/or directly on building façades of high quality and does it complement the overall architectural design of the development? Specifically, has the screening been designed with appropriate materials and in a correct colour?

Materials and finishes

- Is the choice of materials correct in terms of functionality and safety and does it contribute positively to the overall architectural design and surrounding context? Do the materials enhance the character of the streetscape?
- Are the materials used for the building and/or external areas of high quality, well detailed and hardwearing? Will they weather well with time?
- In the design of building exteriors and architectural elements, is use made of traditional local materials or have modern equivalents been deployed? Are these acceptable?
- Have contextual specificities been considered in the choice of materials and finishes, particularly in the more sensitive contexts such as Urban Conservation Areas?
- Is it desirable to use specific materials on building exteriors and have creative and innovative solutions been considered in their design?
- Have distinctive details been incorporated in the design of the development in terms of the materials deployed?
- In medium- and large-scale developments, is it more appropriate to use contemporary materials? Have the design implications of large glazed areas been studied, particularly in environmental terms?
- Does the choice of materials in the design of external areas aid all users, particularly the more vulnerable groups? Does it provide for safe and hardwearing surfaces?

Colour

- Do building colours relate positively to the surrounding context?
- Is it appropriate to follow the existing colour palette, if present within the immediate context? Have the implications on medium- and long-range views also been studied?
- Does the colour of architectural elements, such as apertures, complement that of the building exterior and does the choice of colour help to unify different building elements together?

ANNEXES

Annex 1: Vehicle Parking Standards

USE	Standard (Car Park Spaces)			REMARKS
	LOW	MEDIUM	HIGH	
DWELLING				
<i>Residents</i>	1	2	3	<i>Either covered (in a garage) or open air</i>
<i>Visitors</i>	1	1	2	
<i>Total</i>	2	3	5	
SHELTERED HOUSING				
<i>Per Household</i>	1	2	3	<i>Allows for visitors</i>
<i>Per Warden¹</i>	1	1	1	
OLD PEOPLES HOME				
<i>Per Resident</i>	0.25	0.33	0.5	<i>Allows for visitors</i>
<i>Per Employee 1</i>	1	1	1	
HEALTH CENTRE (polyclinic) AND SURGERY				
<i>Per Doctor¹</i>	1	1	1	<i>Plus dwelling standards, if provided</i>
<i>Per Other Staff 1</i>	0.5	0.75	1	
<i>Per Consulting Room</i>	1	1.5	2	
HOSPITAL				
<i>Per Doctor¹</i>	1	1	1	<i>Plus dwelling standards, if provided</i>
<i>Per Senior Administrator 1</i>	1	1	1	
<i>Per Other Staff¹</i>	0.5	0.75	1	
<i>Per Bed</i>	0.1	0.5	0.66	<i>For Visitors</i>
SCHOOL²				
<i>Per Teacher</i>	0.6	0.8	1	
<i>Per Other Staff</i>	0.5	0.75	1	
<i>Per Pupil</i>	0.1	0.2	0.3	<i>For parents</i>
OFFICE				
<i>Per 50sq.m³</i>	1	2	3	<i>Depends on visitor volumes</i>
SHOPPING				
<i>Per Employee</i>	0.33	0.5	0.66	
<i>Per 50sq.m³</i>	1	2	5	<i>For customers</i>
INDUSTRY OR WAREHOUSE				
<i>Per 150sq.m³</i>	1	1	1	<i>Depends on employee density</i>
HOTEL⁵				
<i>Per Resident Staff</i>	1	1	1	<i>Plus 1, 1.5, 2 coach spaces per 50 guest bedrooms</i>
<i>Per Non-Resident Staff 1</i>	0.33	0.5	0.66	
<i>Per Guest Bedroom</i>	0.2	0.25	0.33	
RESTAURANT, BAR OR CLUB				
<i>Per Resident Staff</i>	1	1	1	

<i>Per Non-Resident Staff</i> ¹	0.33	0.5	0.66	
<i>Per 50sq.m</i> ⁶	5	7.5	10	
ADULT EDUCATION AND SIMILAR INSTITUTIONS				
<i>Per Employee</i> ¹	0.6	0.8	1	
<i>Per Attendee</i> ¹	0.6	0.8	1	
CHURCH, CHAPEL, CATHEDRAL, THEATRE OR CINEMA				
<i>Per Seat</i>	0.1	0.3	0.5	<i>Depends on catchment area</i>
CEMETERY				
<i>Per 50 plots</i>	0.75	1	1.25	
SPECTATOR SPORTS				
<i>Per Participant</i>	0.33	0.5	0.66	<i>Plus bus/coach parking</i>
<i>Per Seat</i>	0.1	0.2	0.3	
PARKS AND RECREATION	<i>Dependent on estimated car park usage at peak times</i>			

Notes:

- 1) *Number is maximum number in the premises at any one time, including an allowance for shift changeover periods*
- 2) *Provision should also be made for school buses, depending on estimated numbers at peak times*
- 3) *Gross lettable floor area*
- 4) *Applies to car-based shopping developments e.g. superstores*
- 5) *Excluding facilities open to the public*
- 6) *Gross customer floor space*

Annex 2: Interpretation of Height Limitation

Height limitation shall be interpreted as follows:

Number of Floors	Allowable Maximum Height in Metres Without Basement	Allowable Maximum Height in Metres With Basement	Allowable Maximum Height in Metres With Semi-Basement
<i>1</i>	<i>7.70</i>	<i>8.60</i>	<i>9.80</i>
<i>2</i>	<i>11.40</i>	<i>12.30</i>	<i>13.50</i>
<i>3</i>	<i>15.40</i>	<i>16.30</i>	<i>17.50</i>
<i>4</i>	<i>19.90</i>	<i>20.80</i>	<i>22.00</i>
<i>5</i>	<i>22.90</i>	<i>23.80</i>	<i>25.00</i>
<i>6</i>	<i>26.90</i>	<i>27.80</i>	<i>29.00</i>
<i>7</i>	<i>29.90</i>	<i>30.80</i>	<i>32.00</i>
<i>8</i>	<i>33.40</i>	<i>34.30</i>	<i>35.50</i>

